

SPICER MANUFACTURING COMPANY, SOUTH PLAINFIELD  
WORKS  
(Spicer Manufacturing Corporation, South Plainfield Works)  
333 Hamilton Avenue  
South Plainfield  
Middlesex County  
New Jersey

HAER NJ-144  
*HAER NJ-144*

PHOTOGRAPHS

WRITTEN HISTORICAL AND DESCRIPTIVE DATA

HISTORIC AMERICAN ENGINEERING RECORD  
National Park Service  
U.S. Department of the Interior  
1849 C Street NW  
Washington, DC 20240-0001

# HISTORIC AMERICAN ENGINEERING RECORD

## SPICER MANUFACTURING COMPANY, SOUTH PLAINFIELD WORKS

(Spicer Manufacturing Corporation, South Plainfield Works)

**HAER No. NJ-144**

Location: 333 Hamilton Avenue  
Borough of South Plainfield  
Middlesex County  
New Jersey

U.S. Geological Survey Plainfield Quadrangle  
UTM Coordinates 18.549712.4491934

Dates of Construction: c1910-1926

Present Owners: DSC of Newark Enterprises, Inc.  
70 Blanchard Street  
Newark, NJ 07105

Present Use: Demolished

Significance: The South Plainfield Works, originally developed by the Spicer Manufacturing Company beginning in 1910, was a nationally-significant center for the manufacture of universal joints and propeller shafts for automobiles and aircraft. The complex was associated with Clarence Spicer's design and manufacturing improvements, and under Charles Dana's management was the first phase in the evolution of the Spicer Manufacturing Corporation as a multi-plant supplier of a wide range of automobile parts. A wide range of building types in a small area reflected contemporary industrial architectural design choices as well as the planning constraints of a fast-growing metal-working enterprise.

Project Information: Surviving structures of the former South Plainfield Works were part of the Cornell-Dubilier Electronics Superfund Site, and were demolished in 2007-2008 as part of site remediation activities outlined in the September 2004 Record of Decision as administered by the U.S. Environmental Protection Agency and the U.S. Army Corps of Engineers. Federal authority brought the project under the purview of federal acts and regulation protecting significant cultural resources from adverse project effects.\* Prior to demolition, the Spicer Manufacturing Corporation structures were determined eligible for inclusion on the National Register of Historic Places by the New Jersey State Historic Preservation Office, because of the South Plainfield Works' significance in American transportation history. Documentation of the plant to standards of the Historic American Engineering Record was completed to mitigate the removal of the significant resources.

---

\* National Historic Preservation Act of 1966 (PL 89-655), the National Environmental Policy Act of 1969 (PL 91-190), the Archaeological and Historical Preservation Act (PL 93-291), Executive Order 11593, Procedures for the Protection of Historic and Cultural Properties (36 CFR Part 800).

**SPICER MANUFACTURING COMPANY, SOUTH PLAINFIELD WORKS**

(Spicer Manufacturing Corporation, South Plainfield Works)

HAER No. NJ-144

(Page 2)

Project Manager and Historian

Michael S. Raber

Raber Associates

81 Dayton Road, P.O. Box 46

South Glastonbury, CT 06073

860/633-9026

Associate Historian

Eugene J. Boesch

Malcolm Pirnie, Inc.

104 Corporate Park Drive

White Plains, New York 10602

845-628-3826

Photographer and Electric Power Historian

Gerald Weinstein

40 West 77th Street, Apt. 17b

New York, NY 10024

212/431-6100

Additional Photography

Thomas R. Flagg

70 West 95th St, #23H

New York, NY 10025-6738

212/864-1006

## **Summary of Significance**

The Cornell Dubilier Electronics Superfund Site in South Plainfield, New Jersey included fifteen structures associated with the Spicer Manufacturing Company (SMC) and its successor firm, the Spicer Manufacturing Corporation (SMCorp), built during the period 1910-1929. Representing most of the major industrial buildings used by these firms at this site, the former Spicer plant was significant in American automobile history as the first major center for the manufacture of universal joints and propeller shafts for automobiles and aircraft, and for plant association with Clarence Winfred Spicer and Charles Anderson Dana. Spicer was the founder, first president, creative force, and engineering genius of the Spicer firm. Over the course of his engineering career, Spicer patented 40 innovations that improved vehicle safety and performance. Charles Dana was the firm's second president. His entrepreneurial and financial skills saved the company from potential collapse, and transformed it into a multi-faceted giant in the early twentieth century automotive industry. Among its other contributions, the firm participated in the production of trucks for the U.S. Army during World War I. The plant, known as the South Plainfield Works within the firm's widening scale of operations, was also significant for the wide range of industrial building types erected within a small area, reflecting contemporary industrial architectural design choices as well as the planning constraints of a fast-growing metal-working enterprise. Although Clarence Spicer introduced a number of manufacturing innovations at the plant, all equipment associated with his work was removed by the early 1930s, and site-specific documentation on manufacturing methods remains limited.

The universal joint drive system for automobiles, developed by Spicer in 1902-1903, replaced the older chain-and-sprocket method of transferring power from engine to wheels, resulting in the appearance of powerful, reliable motor vehicles which attracted American consumers in increasing numbers. Through his development of the universal joint and propeller shaft drive, generally adopted through the twentieth century, Spicer freed the early automobile of many perplexing problems and handicaps caused by the chain-and-sprocket drive. While the principal of the universal joint was an old one, it had not been applied successfully for use in the automobile up to the time of Spicer's application. With Spicer's patented invention, the production of American automobiles increased dramatically. This growth in car production and the widespread use of the universal joint are related. Clarence Spicer's development of an efficient, reliable joint useable in automobiles and trucks enhanced the expansion of the automotive industry, as well as the related demand for more and improved universal joints -- especially those designed and manufactured by Spicer firms. By 1905, Spicer was considered "The Universal Joint Man," the leading innovator and manufacturer of the product in this country, if not the world.

The expansion of the automobile industry is reflected in the nearly 20-fold increase in automobiles produced between 1904 and 1913, from approximately 23,000 to 500,000. By 1910, due largely to Spicer's earlier, revolutionary design work on universal joints, ninety percent of all automobiles used universal joints and propeller shafts, with the vast majority made by Spicer. The percentage was greater for the more expensive American cars (Spicer Universal Joints 1925:13). Within ten years, every car used at least one Spicer-designed universal joint (Spicer Manufacturing Corporation 1929c).

## **Company Founders, History, and Industrial Significance**

### **Clarence Spicer and His Inventions**

Clarence Winfred Spicer (1875-1939) grew up on a large dairy farm in West Hallock, now Edelstein, Illinois. According to Spicer, his life-long interest in machines and mechanical engineering was traceable to a childhood experience in his father's creamery when he helped install and maintain its refrigeration system, reportedly the first in that part of the country (Dana Corporation 1954:1). As a youth and young adult, Spicer continued to be fascinated by all things mechanical but his real affection apparently turned to the newly-developing motor car. He reportedly "knew every nut and bolt of the automobiles which he drove" spending "many a night tuning up his motor car so that he could beat every other car on the road" (Dana Corporation 1954).

Clarence Spicer was a life-long, devout Seventh Day Baptist, which probably influenced some of the progressive social policies introduced by the SMC for its workers as well as Spicer's selection of a northern New Jersey location for his industrial ventures. The Seventh Day Baptist faith originated as a separatist movement during the mid-seventeenth century in England. According to Wardin (1995), they are a "covenant people based on the concept of regenerate membership, believer's baptism, congregational polity, and scriptural basis for belief and practice." They honor the Sabbath on Saturday, the seventh day of the week, and place great emphasis on freedom of thought and conscience. Characteristics of the faith include a strong emphasis on missionary activities, educational endeavors, ecumenicity, and civic responsibility, particularly enlightened or progressive social practices for the benefit and improvement of individuals. The goal of implementing such principals and practices was to make for a more Christian society. The number of adherents to the faith has never been large, with less than 4,900 members organized into 78 churches existing in the United States as of 1995 (Spalding 2005; Sanford 2005). Church membership during the Spicer period was slightly smaller, although concentrated in only a few locations nationwide. The relatively small number of adherents in the faith would have permitted individuals to have direct or indirect personal knowledge of large segments of the church membership. One Seventh Day Baptist congregation in Piscataway, New Jersey — which at the time included South Plainfield — had been vibrant since 1705, and it was there Spicer went to start his business (Wardin 1995).\*

Around 1895, Spicer entered Alfred University, in Alfred, New York, receiving a Bachelor of Science degree from the school in 1899 (Spicer n.d.:1). Other sources, however, place him at the Alfred Academy, a preparatory school in Alfred, between 1891 and 1894, and spending the subsequent five to six years "inventing things" (Dana Corporation 2004:23). Both institutions were originally started by the Seventh Day Baptist's Education Society, which established open denomination schools and academies in areas where public education was not readily available (Wardin 1995). In 1900 Spicer entered Sibley College at Cornell University to further his engineering knowledge. By 1902, while a student at Sibley College, Spicer had become interested in the problem of improving the method of power transmission in automobiles. As part of a school project, Spicer designed and built a new type of automobile with right hand drive and a power system utilizing a universal joint – propeller shaft drive specific for vehicles. College authorities, particularly Robert Thurston, the Dean of Sibley College and a pioneer in mechanical engineering, apparently recognized

---

\* A little mentioned aspect of Clarence Spicer's life during his years in South Plainfield is that he served as a Lieutenant in the Motor Corps of the Home Defense Guard. During a period in early 1919, he served as the acting commander of the Motor Corps (Patterson 1919). His desire to serve likely also derived from his Seventh Day Baptist roots.

## SPICER MANUFACTURING COMPANY, SOUTH PLAINFIELD WORKS

(Spicer Manufacturing Corporation, South Plainfield Works)

HAER No. NJ-144

(Page 5)

the importance of Spicer's project, providing him with sufficient time, and possibly resources, to develop his ideas and the resulting vehicle which Spicer described as experimental (Dana Corporation 2004:23). Thurston went on to become a trusted mentor to Spicer, eventually advising him to file a patent on his universal joint design. Thurston, himself, was a remarkable person, serving as the first president of the American Society of Mechanical Engineers. He counted among his professional acquaintances individuals such as Alexander Graham Bell, Thomas Edison, John Ericsson and Lord William Thompson Kelvin (Dana Corporation 2004:23). Thurston's influence must have had on the young Spicer, may have been profound.

Referring to the experimental car, Spicer later stated that:

“So far as I know, this automobile was the first to have a power plant under a hood in front, and the first steamer to use an atmospheric condenser to reclaim the exhaust steam. In connection with this, two patents were issued to me on oil burners during my junior and senior years. Furthermore, this layout in my sophomore year was the beginning of the Spicer Universal joint” (Spicer Manufacturing Corporation 1929: 2).\*

The universal joint system Spicer developed was an innovative engineering solution to alleviate the inherent problems of a chain-and-sprocket drive and an immense improvement over other systems and ideas for automobile power drives current at the time. A universal joint is a flexible connection between two shafts permitting one to drive the other even if the shafts are not in line. Use of the universal joint for transmitting power mechanically through an angle was conceived in Europe by the 13<sup>th</sup> century, and is still often called a Cardan joint there after the Italian mathematician Jerome Cardan (1501-1576), who is generally credited with discovering its governing principal. In Great Britain and the United States prior to the twentieth century, the device was referred to as a Hooke's coupling, after the work of the English experimental philosopher Robert Hooke (1635-1703) who developed the mathematical aspects of the universal joint and was granted a patent for one in 1664 (Figure 2; Dyke 1919: 43; Spicer Manufacturing Corporation n.d: 1; 1920a: 7; 1926:3; Spicer, C.W. 1926: 3).

Shaft-drive automobiles have one end of the drive shaft attached to the transmission shaft — which is on the frame — and the other end connected to the axle which is subject to constant vertical movement. Universal joints placed at the front and rear ends of the drive shaft eliminate the shaft jamming in its bearings from this movement (Dyke 1919: 43). Prior to 1902, a practical universal joint suitable for use in an automobile did not exist. A few French automobiles were being designed for what later came to be known as the propeller-shaft drive, but the universal joints employed were crude, open-type designs with no provision for lubricant retention or dust exclusion. In 1901, the Autocar Company built the Type VIII, the first American propeller-shaft-driven car. In each of these designs, however, the propeller shaft was fixed in place with crude joints that seized up and shattered easily (Dana Corporation 2004). None proved to be satisfactory or commercially successful. By 1910, however, due largely to Spicer's earlier, revolutionary design work on universal joints, ninety percent of all automobiles used universal joints and propeller shafts. The percentage was greater for the more expensive American cars (Spicer Universal Joints 1925:13). Within ten years, every car used at least one universal joint (Spicer Manufacturing Corporation 1929c).

---

\* Unfortunately, the SMCorp sold a load of old machines as scrap metal in 1928 which included the experimental car. The car was evidently scrapped soon after the sale (Boesch 2006: 3-10).

## SPICER MANUFACTURING COMPANY, SOUTH PLAINFIELD WORKS

(Spicer Manufacturing Corporation, South Plainfield Works)

HAER No. NJ-144

(Page 6)

Spicer's recorded design for his car and universal joint dates to 1902. Spicer's innovative design placed the motor under the hood in front of the car and required that universal joints be strong, compact, and provide suitable freedom of movement to the drive shaft. The joints also needed to be protected from the dust, dirt, and stones so common along the contemporary roads and some methods to keep them lubricated. Spicer's simple solution was to encase the joint. He received a patent in May 1903 for a casing around a joint similar in design to Hooke's coupling (Spicer, C.W. 1903). The design was published in a patent journal and was soon drawing the attention of automobile manufacturers interested in his invention. They contacted Spicer and requested him to supply the joints or license their manufacture, sparking the 1904 beginnings of his efforts to manufacture and sell his designs as discussed below (Spicer Manufacturing Corporation 1920a).

Numerous improvements in the design of the universal joint were subsequently patented and the joints soon became the industry standard for power transmission. The original Spicer Universal Joint was spherical in appearance and consisted of two similar yokes, connected by a single-piece journal cross, enclosed in a spherical shell supported by projections on two of the cross journals. This construction presented difficulties in assembling the car. To overcome these problems, in the next generation of joints developed by c1906, one of the yokes was made in the form of a disc and the shell or casing in semi-spherical form. A telescoping member was added to compensate for shaft length variation incidental to axle movement. To facilitate rapid assembly to a car further, the disc form of yoke was made in two pieces c1906-1912; one part, known as the flange yoke, remaining a unit of the joint proper; the other part, known as the companion flange, becoming essentially a unit of the transmission or axle. In this form, the propeller shaft, with its universal joint at each end, is a unit complete in itself, and its application is a simple matter of coupling the flanges to the vehicle. In later versions of the joint, an auxiliary casing was added as a further protection against the entrance of dust or other foreign matter, particularly gritty slush such as is encountered on wet roads. The auxiliary casing was provided with packing and held in contact with the inner casing by means of a threaded nut. Experience showed Spicer that the operator usually neglected to make the necessary adjustment between the two casings to compensate for packing wear, so the treaded nut was discarded and a spring was adopted c1912-1917 with a suitable retainer that made adjustments automatically. Originally, all two-joint assemblies were provided with "solid" shafts. As good roads developed, higher car speed was demanded. This coupled with the tendency of longer wheel bases and higher engine speeds, introduced the problem of shaft whip. To meet this condition, the "tubular" shaft was developed by 1917. With this construction, because of its extreme lightness, a very much larger diameter is obtainable without increasing the weight. The speed in revolutions per minute at which a shaft of a given length will not "whip" or "whirl" can be increased very materially by enlarging the shaft diameter. The use of tubing permits this increased diameter without corresponding increase in weight (Figures 3-5; Spicer Manufacturing Corporation n.d.: 10; 1919).

From the flange yoke, the torque load from the transmission shaft is transmitted through the journal cross piece to a yoke at the end of a short sleeve, and then to the propeller shaft through a multiple-spline slip joint welded to the shaft. The slip joint has ample bearing surface to permit free lengthwise movement while carrying full torsional load. From the propeller shaft, the torque is transmitted to the rear-axle pinion shaft through the second universal joint, which is a duplicate of the first except for the omission of the yoke welded to the rear end of the shaft (Figures 4-5; Spicer n.d.: 20).

In 1925, Clarence Spicer provided more details on his early universal joints:

“The first Spicer Universal Joints were of spherical form with the casing split longitudinally. The possible use of what are now known as transmission brakes suggested the combination of the universal joint with the brake drum web which was done, bringing about the present form of flanged casing in 1904. Omitting the brake drum but retaining the flange construction and we have the “disc yoke” type of joint which was the standard for a year or more. The next obvious step offered in the January 1905 catalogue was to omit the hub from the disc yoke and substitute a companion flange to form a flange coupling, this making it easier to assemble the unit into the car and incidentally to avoid the necessity of the joint proper being hastily assembled by inexperienced workmen. The latter point was especially important at the time (1905-1906) because of the comparatively easy deformation of the bronze bushings, which were standard equipment up to 1908. The October 1907 catalog stated that hardened and ground steel bushings could be furnished at an extra cost of \$1.30 to \$1.75 list per joint. The same catalog for the first time showed a line of sizes from 000 to 1,000, some of which were equipped with outside castings to aid in the exclusion of foreign substances from the joint. Only examples of the 000, 00, and 0 sizes were ever made and they were omitted from later catalogs. The January 1906 catalog also offered a double universal joint consisting of two closely coupled single joints for use especially between engine and transmission but also applicable to some conditions which require an operating angle greater than can be obtained by a single joint” (Spicer Universal Joint 1925:6-8).

The creativity of Clarence Spicer as an inventor is illustrated by the fact that he acquired at least forty patents during his career. Twenty-seven American patents and five French patents were for modifications and improvements on universal joints and propeller shafts. Many of Spicer’s patents were awarded before his first universal joint patent was issued. As he indicates in the patent notation cited above, the two patents concerning oil burners were for liquid fuel burners used in conjunction with steam boilers, and which predated the universal joint patent. Some of the other noted inventions for which he received patents were for a machine for balancing propeller shafts, another for producing welded tubing, a heat-treating furnace, a conveyor for that furnace type, a railroad generator drive, and a method for easily erecting a wire fence (Dana Corporation:3).

In addition, by 1925 some noted and industry adopted revolutionary developments for which Clarence Spicer was responsible included (Spicer Universal Joints 1925: 9-13):

- Pioneering work in heat treatment of metals;
- Laboratory research leading to lubricant retention in joints and other vehicle locations that were several times better than previous conditions;
- Research on tapers which, prior to Spicer’s work, were not steep enough for general use in attaching universal joints to shaft ends of motor cars. With no prior data to guide him, Spicer studied taper design and decided to standardize taper contractions to 1.5 inches per foot or 1 in 8. This standard, along with other Spicer detail dimensions, came into general use and was eventually adopted by the Society of Automotive Engineers as the standard for automobile taper shaft fittings, permitting the interchangeability of replacement tapers in vehicles;
- Development work by Spicer on square and multiple spline broaching tools in use in nearly every motor car and parts factory after 1910. The tools were used to make square hole slip joints required for the manufacture of universal joints.



**Spicer Manufacturing History under Clarence Spicer c1904-1914**

In the spring of 1904, prior to completing a fourth year at Cornell, Spicer left the school to engage full-time in the manufacture of his universal joint, and moved to Plainfield, New Jersey to establish a shop.\* There he completed an arrangement with the owner of the Potter Printing Press Company, one of his relatives, to manufacture his initial orders of universal joints in their plant according to his specifications. The Potter plant began producing universal joints on April 1, 1904. An objective of the business, according to Spicer, was to “anticipate the universal joint requirements of tomorrow and therefore to constantly improve in every possibly way the design, material, and workmanship” of the product (Dana Corporation 2004: 11, 19).

The choice of the Plainfield area for his business was an easy one for Clarence Spicer and his wife Anna, for professional and personal reasons. Plainfield was a growing town with adequate rail transportation for bringing in supplies and equipment and shipping out finished product, and the growing United States automobile industry was then situated largely in the northeast part of the country. Spicer had two relatives in the South Plainfield area, one the owner of the Potter Printing Press Company, and the second a cousin named George Babcock who became the biggest financial supporter of the early Spicer business (Dana Corporation 2004:15). As discussed above, the Seventh Day Baptist Church also had a strong congregation in the Piscataway area (including South Plainfield) and would have provided spiritual and emotional support for Spicer and his wife.

Spicer’s initial arrangement with the Potter Printing Press Company plant was short lived. After a few universal joints had been produced, the company received a large order for printing presses and could no longer afford the manpower to accommodate Spicer’s needs. Spicer then rented space in the Potter plant building and started manufacturing joints with the help of three or five new employees, the first he hired while operating as C.W. Spicer. The first completed orders of universal joints were shipped in September 1904, to the Corbin Motor Vehicle Company in New Britain, Connecticut and the National Motor Vehicle Company. Orders more than doubled over the next eight months. C.W. Spicer was incorporated as the Spicer Universal Joint Manufacturing Company in May 1905, most likely to facilitate financing. The first company directors were Clarence W. Spicer, David E. Titsworth, Frank A. Pope, Harrison Coddington, and Joseph A. Hubbard. Not surprisingly, Clarence Spicer was elected President of the new company (Spicer n.d.:4), an office he held until February 28, 1916 when Charles Dana was elected President. During the first twelve months after incorporation, the company posted sales of close to \$40,000. By about this time, Spicer became known in the industry as “C.W. Spicer, the universal joint man”, nomenclature he proudly used in his early advertising. As the Universal Joint man’s reputation grew, company sales more than doubled to \$83,000 by 1907, when eighty people were employed at the South Plainfield plant (Spicer Manufacturing Company 1920a: 4; Dana Corporation 2004: 3, 17; Industrial Directory of New Jersey 1907).

Growth of the business soon forced Spicer Universal Joint to move from the Potter facility, acquiring a small, 1,152 square foot building on Madison Avenue in Plainfield c1908. There, Spicer and six or twelve or his eighty employees manufactured universal joints and propeller shafts at the rate of 150 sets per month. In 1909, the company changed its name to the Spicer Manufacturing Company, and added a forge shop to the plant at Plainfield. Prior to acquiring the forge, the company was purchasing drop forgings from which universal joints are made from other companies (Spicer Universal Joints 1925: 2). The new equipment

---

\* Although Spicer left school prior to receiving an advanced degree, his contributions to the field of automotive technology were recognized in 1935 when he was honored with a Doctor of Science Degree from Alfred University, his alma mater (Spicer Manufacturing Corporation 1920a: 5).

## SPICER MANUFACTURING COMPANY, SOUTH PLAINFIELD WORKS

(Spicer Manufacturing Corporation, South Plainfield Works)

HAER No. NJ-144

(Page 9)

reportedly enabled the company to more effectively control the raw material going into their products, reflecting a growing company philosophy of self-sufficiency in its manufacturing processes. The noise of the forge's operation hammers at Plainfield soon caused ill feeling in what was then an urban neighborhood, forcing Spicer to relocate to the more rural environs of South Plainfield in 1910. There, the company acquired a 2.09 acre tract south of the Lehigh Valley Railroad and Bound Brook and east of Hamilton Avenue, erecting or using four factory buildings, one of which may have already been located on the parcel. This original Spicer tract became the northwestern most corner of the South Plainfield Works. At the time of Spicer's move, South Plainfield was part of the Township of Piscataway. It did not break away and form its own township until 1926, due in large part to the area's industrial growth (Figures 1, 6-7; Industrial Directory of New Jersey 1909; Dana Corporation 2004:17).

The efficiency of the Spicer universal joint reportedly was investigated by the Mechanical Engineering Department of the University of Kansas between 1911 and 1914 and reported in academic papers presented to the American Society of Mechanical Engineers in December 1914 and to the Society of Automobile Engineers in January 1915. The results of the investigation reportedly demonstrated that as of that period (Spicer Universal Joint 1925: 3):

“...the efficiency of the universal joints to be above 99% under all normal working conditions; in other words that the loss in power transmitted due to the Spicer Universal Joints is less than 1% and is therefore an entirely negligible quantity. From this it may be positively stated that the Spicer Universal Joints are by far the most efficient of the important parts of the mechanism of the motor car. For comparison, it may be noted that the loss in a single pair of first class gears usually amounts to 5% to 20% and the efficiency of a single pair of bevel gears usually runs from 4% to 12% or even 15%, while the motor itself wastes under average working conditions at least 80% of the energy in the fuel.”

Spicer also initiated a long-standing company policy of soliciting individual client car manufacturer's input as much as possible into product design and production, generally a new business philosophy at the time. According to a later company history, “This co-operation between specialist and car manufacturer has resulted in the reduction of repairs and other difficulties so far as universal joints are concerned to almost nothing. In spite of the fact that there are many hundreds of thousands Spicer joints in operation, the repair business in connection with them is not sufficient to be attractive to the smallest job shop” (Spicer Universal Joints 1925: 1-2).

By 1913, when the company added its own heat treating plant to enhance output quality, Spicer's operation was a world leader in the production of universal joints and propeller shafts, a position it held for at least the next half century. Over 100 vehicle manufactures, parts suppliers, and repair shops were customers of the SMC, which during this period counted more than 240 people as employees, a 300 percent growth from the 1909 employment figures (Industrial Directory of New Jersey 1912). These customers included such well known companies as Cadillac, Chevrolet, General Motors, Diamond T., E.R. Thomas, Chalmers, Flint Wagon Works, Auburn, Hudson, J.I. Case, and Oakland, as well as Newstadt Auto Supply, Newark Garage and Repair, and Imperial Garage (Dana Corporation 2004:19). The SMC also was attempting to sell its universal joints in France and Belgium by 1911 through the renowned French import-export concern of J. Glaenzer (Dana Corporation 2004:21). Spicer himself was largely responsible for the growing client list, spending much of his time traveling to demonstrate his product to potential buyers (Dana Corporation 2004: 19). The growth potential for the business apparently was so great that Spicer soon hired at least three independent

## SPICER MANUFACTURING COMPANY, SOUTH PLAINFIELD WORKS

(Spicer Manufacturing Corporation, South Plainfield Works)

HAER No. NJ-144

(Page 10)

sales agents to visit prospective customers on behalf of the company. Advertisements for universal joints and other products appeared in automotive trade publications and in overseas markets (Dana Corporation 2004: 19). Spicer's sales have been valued at approximately 10 million dollars in 1913 which is equivalent to about 200 million in sales today.

The rapid growth of the SMC, reflecting the growth of the automobile industry placed a great strain on the business' resources and on Spicer's time and abilities, likely causing him much stress. According to a company history:

“Ever-increasing orders were followed by more complex, large scale manufacturing problems. New space and equipment were constantly needed to keep up with company orders. Short and long term, the company sorely needed money. Clarence's words on the struggles: ‘So many different customers demanding immediate shipments that the very best we could do was get them out in a way to keep the customers in even half-way good humor even at the expense of shop cost.’ ” (Dana Corporation 2004: 21).

With Spicer's success, many competitors entered the universal joint business, selling prices at lower cost to gain a foothold in the industry. Many of these competitors reportedly were infringing upon Spicer's joint patents, with the resulting lawsuits placing further strain on company resources (Dana Corporation 2004: 21).

These circumstances produced continued negative effects on the company, and by 1913 Spicer recognized that in order for his company to continue to grow, much less survive, additional capital and talent were needed. Perhaps belatedly, it was recognized by Spicer and the company's Board of Directors that the inventive genius and drive of Clarence Spicer were not sufficient to overcome growing problems and continue making the company a success. These problems and the issues faced by the company are described by the Dana Corporation (1954: 9):

“Competition had sprung up. Universal joints were in great demand and had to be produced in larger quantities. Costs had to be kept in line to meet competition. There were production problems, and many other problems calling for all the time, thought, energy, and vision of a high caliber, experienced business man. The lack of these qualities in the original management brought the company to the brink of bankruptcy about 1913 and something had to be done to remedy this situation.

The specter of company failure for Spicer was not inconceivable given that by the second decade of the twentieth century over 1,500 manufacturers' and supplies within the fledging automobile industry had already gone bankrupt” (Dana Corporation 2004: 21).

By late 1913, the SMC was in search of new funds, and perhaps more importantly, someone with the business acumen to reorganize and successfully guide the business. Some funds were acquired early in 1914 when the SMC raised \$250,000 through a mortgage acquired from the Columbia Knickerbocker and Trust Company to cover a bond issued by the company for the purpose of extending and improving its South Plainfield plant (*Plainfield Courier News* 1914). Earlier, however, on December 13, 1913, the Company's Board of Directors met in a special meeting to consider a loan from a New York prosecuting attorney and entrepreneur named Charles Anderson Dana.

## SPICER MANUFACTURING COMPANY, SOUTH PLAINFIELD WORKS

(Spicer Manufacturing Corporation, South Plainfield Works)

HAER No. NJ-144

(Page 11)

### Charles Dana and the Growth of the Spicer Manufacturing Company c1914-1930

Charles Anderson Dana (1881-1975) was born in New York City, and received a law degree from Columbia University in 1904. He immediately entered the law office of Edward M. Shepard, counsel for the Pennsylvania Railroad, and worked on infrastructure projects for the entry of the railroad into New York City. After a few years, Dana joined the law firm of Strong and Cadwallader for three years to gain experience in corporation law. Following this tenure, Dana joined the staff of the New York District Attorney to gain experience in actual court practice and jury cases. While serving as an Assistant District Attorney, Dana assisted in the prosecution of Harry K. Shaw for the murder of Sanford White, the renowned architect, thus participating in one of the most famous American murder trials. While practicing law, Dana also was elected three times as a Republican member of the New York State Legislature from the 27th Assembly District in New York City. While an Assemblyman, he became intimately associated with the then Governor of New York, Charles Evans Hughes. It was Dana who introduced a bill permitting the issuance of transfers from one transportation line to another in New York City, including horse cars, cable cars, trains, etc. (Dana Corporation n.d.: 2).

Dana's attention was called to the SMC in 1913 by a group of New York bankers associated with the Spencer Trask and Company investment bank. Clarence Spicer had earlier approached the bank in order to attempt to secure financing. The Trask bankers informed Dana, who coincidentally also was visiting the bank relatively soon after Spicer's visit, about the struggling young Spicer automotive company, which possessed excellent possibilities for the future but also had serious financial problems (McPherson 1973:10). Dana quickly became interested in the company, recognizing its potential. Following the advise of his friend, Charles W. Nash, the President of General Motors, and reportedly with Nash's promise of new General Motors contacts with the SMC, Dana traveled to South Plainfield to see the firm and meet Clarence Spicer first hand. An anecdotal account relates that as Dana was touring the factory with Spicer, they came to the latter's office where the desk was filled with papers. Dana supposedly inquired about the papers whereby Spicer answered that they were new orders. Dana inquired about the Company's bills and debts, whereupon Spicer opened a draw and showed him only a handful of invoices. The large pile of orders compared with the small stack of bills reportedly convinced Dana of the viability of Spicer's business and encouraged him to become involved with it (Dana Corporation 2001; 2004).

Early in 1914, Dana made a \$5000 loan to the SMC, and quickly became the principal manager of the firm's business affairs. He was elected a Director of the company at the Annual Meeting of Company Stockholders on February 24, 1914. The Directors then proceeded to elected Dana Secretary and Treasurer of the company at a salary of \$2,500.00 per year, plus fifty shares of common stock of the company. On April 3rd of that year, Dana resigned his position as Secretary and Treasurer and was elected Vice President of the company. By March 15, 1915, the certified list of stockholders in the minute book indicate that Dana owned 770 shares out of a total of 1,668 company shares or over 46% of the total issue. A little more than a year later, at a Board of Directors meeting on March 28, 1916, Dana was elected President and Treasurer of the Company upon the resignation of Clarence Spicer as President. Spicer was elected Vice President on the same date (Spicer Manufacturing Company n.d.: 1-2). Spicer must have felt some relief at vacating the Presidency of the SMC since from that time forward he no longer had to address financial and company problems, but could concentrate on product improvement and development and on improving methods of manufacture.

**SPICER MANUFACTURING COMPANY, SOUTH PLAINFIELD WORKS**

(Spicer Manufacturing Corporation, South Plainfield Works)

HAER No. NJ-144

(Page 12)

With the settlement of his position and financial interests in the SMC behind him, Dana devoted his energy and rare ability to turning the Spicer business into a successful operation. As the new organization started to function successfully and profits were made, they were placed back into the business to strengthen it and prepare the foundation for its subsequent expansions. Because of this practice, job opportunities were expanded; 464 people were employed at South Plainfield in 1915, better tools developed, other businesses and lines acquired, new and more modern facilities constructed and equipment added, and greater production promoted. This created a reserve of assets for the company sufficient to carry it through down turns in the economy ((Industrial Directory of New Jersey 1915; Dana Corporation 1954:9).

Dana further reorganized the company's corporate structure in 1916. Over the next 15 years, he was responsible for the erection of new subsidiary plants, the addition of new businesses to the Corporation and an increase in manufacturing capacity and sales. The businesses acquired by the Spicer Company, and their years of acquisition, over the next 15 years are shown in Table 1. Most, if not all, of these companies were competitors in one way or another and in financial distress. Dana, therefore, was able to acquire them at bargain prices while also eliminating a SMC competitor (Dana Corporation 2004:42).

**TABLE 1. BUSINESSES ACQUIRED BY THE SPICER MANUFACTURING COMPANY THROUGH 1929**  
(Sources: Dana Corporation 1954, n.d.a)

<b>Company</b>	<b>Year Acquired</b>
Parish Pressed Steel	1919
Salisbury Axle Company	1919
Chadwick Engine Works	1919
Sheldon Axle Company	1919
Snead and Company	1922
Arvac Manufacturing Company	1922
E.J. Hardy and Company	1926
Brown-Lipe Gear Company	1929
Hayes Wheels and Forgings, Ltd.	1929

At a special stockholders meeting held on May 17, 1917, it was voted and approved to sell the SMC and its assets to a new company, owned by a syndicate of bankers headed by Merrill, Lynch and Company, called the Spicer Manufacturing Corporation (SMCorp) as of the close of business on April 30, 1917. The SMC was dissolved as of that date. The new SMCorp had been organized and incorporated on October 12, 1916, in the State of Virginia. The sale to the bankers, however, apparently was not finalized until late September of that year. The purpose of the sale was to raise new capital for the business. Dana, not surprisingly, played a direct, first hand role in the sale, which involved an issue of Spicer common and preferred stock. The corporate association between Merrill and the Spicer Corporation, and its successor company the Dana Corporation, remained at least through the mid-1970s. The stock was used to finance the sale with Merrill Lynch acquiring all of the preferred stock and 20% of the common stock in the first underwriting as part of the financing arrangement. On December 12, 1916, Charles Dana was elected a Director of the new Corporation. A little more than four months later (April 28, 1917), Dana was elected President of the Corporation, a post he held until December, 1948 when he became Chairman of the Board. The SMCorp retained its name until July 12, 1946 when it was changed to the Dana Corporation (Spicer Manufacturing Corporation nd: 1-3).

## SPICER MANUFACTURING COMPANY, SOUTH PLAINFIELD WORKS

(Spicer Manufacturing Corporation, South Plainfield Works)

HAER No. NJ-144

(Page 13)

The SMCorp business and South Plainfield Works expanded considerably after the corporate reorganization. A general description of the Spicer manufacturing process for their universal joint and propeller shaft system, as it existing in 1920 when the plant was at its zenith, is found in a company marketing brochure of that year. According to the pamphlet (Spicer Manufacturing Corporation 1920a: 14-17), as each shipment of steel used to manufacture the product arrives by rail at the plant, it:

“..is tested in the laboratory to insure its compliance with the physical and chemical specifications upon which it was ordered. Only when it has passed this inspection is it released for use.

Spicer Universal Joints and Propeller Shafts begin to take form from the raw steel first in the forge shop. Here the steel is heated in many forges and a score of great drop-hammers turn out a constant stream of roughly shaped yokes and journals. As these fall glowing to the floor, they are collected intowheel-barrows and taken to a battery of great presses which trim up the fins left by the drop-hammers. The roughly formed parts are then sandblasted to remove all scale and afterward machined.

Much of this work is done on machines, which have been specially designed and exclusively developed in the Spicer plant.

When roughly finished to the proper dimensions, the parts are heat-treated. This is one of the most important steps in the entire construction of the Spicer Universal Joints and Propeller Shafts. In the heat-treating room there are rows of great ovens heated by fuel-oil. Here by proper control of the temperature, the physical qualities of the steel can be altered to give it great toughness and strength, or, if the parts are packed in refractory boxes with suitable chemicals, the chemical composition of the steel can be changed so that the outer surface may be made extremely hard. When the outer surface is thus hardened, it is especially well adapted to serve as a bearing surface where great pressures must be withstood.

After heat-treating the parts are finished to exact size by grinding and are then ready for assembly.

In the meantime, in the stamping department, the oil-tight housings have been stamped and drawn from sheet metal, and the cold drawn high carbon steel tubes, which are to serve as shafts, have been cut to the proper lengths. The tubes are then welded at one end to the splined stub shaft of the slip joint and at the other end to one of the universal joint yokes, in electric welding machines.

The welded shafts are then placed in a torsion testing machine. This test places upon the shafts a stress of the same nature, but greater in extent than any they will be called upon to meet in actual use. The vital importance of such a test is obvious and it is a surprise to many to learn that although it was long ago developed by Mr. Spicer, until very recently it was used nowhere else for this kind of work. All shafts must pass the torsion test before going to the assembly shop where the joints are assembled on each end of the shaft. All the component parts have been held to such exact limits by numerous rigid inspections throughout the process of manufacture that the assembly consists in simply putting the various parts together, no hand fitting being required. Absolute interchangeability is found throughout. This insures long life and, in case of accident, ready repair by simply substituting a new part.

## SPICER MANUFACTURING COMPANY, SOUTH PLAINFIELD WORKS

(Spicer Manufacturing Corporation, South Plainfield Works)

HAER No. NJ-144

(Page 14)

When assembled the complete propeller shaft is again carefully inspected although each of the component parts has been thoroughly inspected before assembling. Thus, the complete propeller shaft is accurately and properly assembled from accurately machined and tested parts.

After a final inspection the complete propeller shafts go to the shipping department where they are boxed and dispatched to the purchaser.”

Business apparently remained good for the SMCorp for much of the next decade, with the exception of the years 1920 and 1921, with newspaper articles periodically appearing commenting on the prosperity of the business and that it was working with a full labor force (*New York Times* 1922). Accordingly, the SMCorp continued to expand through much of this period. In 1919, the company initiated an expansion and product diversification program, acquiring the Parish Manufacturing Company and the Sheldon Axle and Spring Company with plants in Michigan and Pennsylvania. At the time, Parish was one of the country’s largest manufacturers of automobile and truck frames while Sheldon Axle was the second largest maker of vehicle axles (*New York Times* 1919). With their acquisition, the SMCorp expanded its involvement and influence as a supplier to the automotive industry and, according to the *New York Times* (1919), made the company “one of the most important factors in the automotive industry.” The *Plainfield Courier News* (1919) commented similarly on the acquisition stating “With the acquisition of these two new companies the Spicer Manufacturing Corporation, already the largest manufacturer of universal joints in the United States, becomes one of the most important factors in the motor industry.”

The entire automotive industry suffered a post war slump in 1920 – 1921 as a result of labor strikes, material shortages, high interest rates, and the general after-effects of World War I. In the United States, vehicle production dropped more than 30 percent while Spicer’s sales dropped from 18 million dollars to five million dollars during that time. Both the automotive industry and the SMCorp began a strong recovery in 1922. The year 1922 also was the year that Spicer was first listed on the New York Stock Exchange (Dana Corporation 2004:41).

Company prosperity after 1922 reportedly was due in large part to the growing popularity of automobiles generally, especially closed sided cars replacing open vehicles, and the freedom they represented to the American population. The American government, responding to the growing population of automobile owners, started a funded program of building new roads nationwide (Dana Corporation 2004: 41). By the mid-1920s, the SMCorp had become foremost in the world in the manufacture of universal joints and propeller shafts. It had grown from its 1,152 square foot factory in Plainfield in 1904, to a preeminent firm that in 1929 had over 625,000 square feet of factory space in the United States and Europe, employing 2,500 people, 820 of who were employed at the South Plainfield plant (Industrial Directory of New Jersey 1927). The 1927 Industrial Directory of New Jersey describes the Spicer plant at South Plainfield as producing universal joints, drive shafts, clutches, drop forgings, sheet metal stampings, screw products, and coil springs with the 820 employees consisting of 700 adult males, 50 adult females, and 50 males and 20 females under 16 years of age. The company’s entire work force produced over 200,000 universal joints per year utilizing in the process 25,000 tons of steel per year (Spicer Manufacturing Corporation 1929b). At least 294 American and European motor vehicle manufacturers, some legendary, used Spicer-made products as standard equipment on their vehicles.

## SPICER MANUFACTURING COMPANY, SOUTH PLAINFIELD WORKS

(Spicer Manufacturing Corporation, South Plainfield Works)

HAER No. NJ-144

(Page 15)

Spicer's propeller shafts were used where it was necessary to transmit the rotary motion of one shaft to another while permitting angular motion in all directions. Besides its use in vehicles, the universal joint was found throughout many industries, particularly in mountings and feed mechanisms on drills and other machine tools. It also is commonly present in agricultural machinery and artillery mountings. In addition to motor cars, two and four wheel drive trucks, and buses, Spicer supplied their propeller shafts to other industries (Spicer Manufacturing Corporation 1918; Spicer n.d.: 8):

Regardless of the diversification of the businesses Spicer catered to, during this period the American automobile industry was becoming more and more centered in the upper mid-west, creating shipping and logistical problems for the company. By 1926, perhaps a year earlier, the Spicer Board of Directors was discussing relocating away from South Plainfield to the Toledo, Ohio area. Other factors may have forced their hand, or at least contributed to the decision. South Plainfield's growth into a commercial and suburban center during the 1910s and early 1920s, largely as a result of the economic stimulus brought to the area by the SMCorp and a few other local industries, resulted in the need for infrastructure development. The SMCorp, and the people and businesses it attracted, needed paved roads, schools, and other public improvements to continue to operate successfully and to serve its employees. Rural Piscataway Township, which at the time included the South Plainfield area, could not afford the necessary costs for such improvements, nor could the SMCorp subsidize such construction. In 1926, in order for more of their tax money to be used to benefit the South Plainfield area, the Borough of South Plainfield was incorporated out of Piscataway Township. However, the new municipality soon found itself embroiled in a local property tax dispute with the SMCorp (Randolph 1989). Rather than continue to fight the municipality, and with much of the automotive industry located in the upper mid-west, the SMCorp decided it was time to leave New Jersey.

The SMCorp began to move from South Plainfield, New Jersey to a newly constructed plant in Toledo, Ohio in 1928. Ultimately, many local residents, included skilled Spicer machinists, forge men, artisans, and other workers left the South Plainfield area and moved to Toledo. Construction on the new SMCorp plant in that city commenced by late 1927, indicating that the corporate decision to move from South Plainfield had been made well before that time (*Toledo Business* 1927). The new plant opened in the spring of 1928 with the arrival of Spicer personnel, equipment, and supplies from South Plainfield (*Toledo Business* 1928a and 1928b). The final movement of personnel and equipment from South Plainfield to the new Toledo plant reportedly was to occur about January 1, 1929, according to then Spicer Vice President, R.C. Carpenter (*Toledo Business* 1928b), but apparently did not happen until February 1<sup>st</sup> of that year. At least one newspaper covered the move from South Plainfield, providing this description (*Plainfield Courier News* 1929a):

“A special Pullman car containing six or eight employees of the Spicer Manufacturing Corporation and their families was attached to a Lehigh Valley train leaving South Plainfield at 12:42 o'clock this afternoon. The employees are members of the sales and engineering staffs, and will be located at the main plant and offices of the company at Toledo, Ohio.

The special Pullman was on a sidetrack a little way from the South Plainfield station, and plant associates of the departing employees and their friends assembled at the car to see the party off. There were probably 75 people in the group around the Pullman.



## SPICER MANUFACTURING COMPANY, SOUTH PLAINFIELD WORKS

(Spicer Manufacturing Corporation, South Plainfield Works)

HAER No. NJ-144

(Page 16)

The special car was attached to the “Chicagoan,” which is due in Toledo at 7:20 a.m. tomorrow. The employees and their families will have a regular circus going out, according to J.S. Berry, treasurer of the company and manager of the South Plainfield plant. “They are a fine lot,” Mr. Berry said, “and the children of the party are naturally having the times of their lives.”

On April 1<sup>st</sup>, 1929, the SMC Corp transferred all remaining assets of the South Plainfield Plant to a new subsidiary, the Plainfield Manufacturing Corporation (Berry 1929a). The *Plainfield Courier News* (1929a), in an article dated February 1, 1929, apparently reflects the uncertainty about the South Plainfield plant’s future that existed at the time. The article states that:

“Charles A. Dana of Bernardsville, President of the Spicer Manufacturing Corporation, is expected to visit the South Plainfield plant this afternoon, and an announcement in respect to the plans of the company for that plant may follow his visit. Even high officials of the company have been in doubt as to what is to be done at South Plainfield, and it is hoped that Mr. Dana’s visit may put an end to some of the suspense.”

The next day’s edition (February 2) of the *Plainfield Courier News* (1929b) reported that upon his visit to the South Plainfield plant, Charles Dana indicated that the SMC Corp had no intention of closing the facility. He did state, however, that universal joints would no longer be made at South Plainfield and that all such production would be at the new Toledo facility. “It’s a matter of economic production,” Dana said. “We can make universal joints more economically at the new plant than we can at South Plainfield and so we are going to make them at the new plant” (*Plainfield Courier News* 1929b). Forebodingly, Dana also stated that he did not know what would be made at the South Plainfield plant.

While documentary evidence exists indicating that Spicer intended to maintain a large and active business in South Plainfield via the Plainfield Manufacturing Corporation, it apparently did not come to pass, likely due to the stock market crash the following fall and the coming depression (Berry 1929b). Regardless of the intentions of the company, by the end of 1929, company headquarters and practically all of its manufacturing equipment had been moved from South Plainfield to the new Toledo facility (Dana Corporation n.d.a).

The Plainfield Manufacturing Corporation apparently served as a holding company for the SMC Corp for its South Plainfield factory and property, portions of which it soon was beginning to lease to other companies. By 1930, the former SMC Corp property was for sale (Dana Manufacturing Corporation 2004:45).

### **Employee Benefit Programs**

The SMC and SMC Corp instituted a number of employee benefit programs at the South Plainfield Works. Some of the earlier, and simpler, programs begun by Clarence Spicer were likely related to his devout Seventh Day Baptist faith with its strong commitment to social activism and community responsibility. The relatively heavy investment in these programs, especially the more extensive ones implemented under Charles Dana’s management, suggest that the more important context was the “welfare capitalism” movement common in American industries from the 1880s to the Great Depression. Emerging from earlier generations of paternalistic management at some factories and mill villages, this movement evolved into welfare programs designed to enhance loyalty and satisfaction among workers, and to discourage unionization (cf. Biggs 1996: 64-70).

## SPICER MANUFACTURING COMPANY, SOUTH PLAINFIELD WORKS

(Spicer Manufacturing Corporation, South Plainfield Works)

HAER No. NJ-144

(Page 17)

Most of the company's employee-related policies post-date Charles Dana's corporate reorganization in 1916, after which increasing profits provided the resources for developing and implementing the policies. With less capital available for non-manufacturing efforts under Clarence Spicer's management, the first employee programs centered on providing inexpensive food (restaurant and other food sales) and organizing clubs and events. Under Dana, these programs were expanded and new ones begun, some of an immediate, practical nature and others with more long-range goals. Programs with immediate worker benefits included providing food stuffs and other merchandise at cost or for free, providing cash rewards for work-related suggestions that were implemented, establishing a hospital and health related programs, instituting a bus transportation system, establishing a newspaper, and establishing a Company Department of Safety. More long-range programs included providing employee housing, life insurance, stock purchase plans, and discounted education programs.

The SMC provided a non-profit restaurant as early as 1912 for the convenience of its employees. The restaurant apparently served meals throughout the day. Not only could employees on their shifts use the restaurant, but workers whose shifts were over could bring their families for free lunches or low-cost meals at other times. By 1917, about 3,500 meals were served on an average work week, even though the restaurant was operating at a loss (Spicer Manufacturing Corporation 1917b; Randolph 1989).

To maintain employee morale the SMC Corp organized and subsidized various company clubs and events for management and floor workers, including baseball, basketball, bowling teams, Smoking Club, Theater Group, Community Chorus, theater nights in New York City, company picnics, vaudeville shows, dances, company theater, clambakes, and golf outings, among others,. While other contemporary companies also held such events, the SMC Corp frequently held theirs at exclusive clubs, horse farms, and restaurants (Spicer Manufacturing Corporation 1920a). There were also raffles and lotteries held by the different plant departments with prizes such as turkeys (Spicer Manufacturing Corporation 1920c, 1920d).

To ensure that its employees could get to work daily and on time, the SMC Corp instituted a free bus transportation system for its employees, serving the greater South Plainfield area. The bus company started by the firm issued bus passes to employees, assigning a specific bus to each person working at SMC Corp. The general public also could use the buses but were charged five cents per round trip ticket (Spicer Manufacturing Corporation 1920e).

The SMC Corp formed a Department of Safety to maintain a clean plant with the goal of making it one of the cleanest in the country, and to ensure that working conditions there promoted worker health and bodily safety. Establishing such conditions would be beneficial to both workers and the company. The Department felt that these goals were achievable if every man worked in harmony with the Safety Department. The Safety Department completed a study by February 1917 whose aim was to improve conditions at the plant to increase productivity and ensure worker safety and morale. The study's recommendations are more accurately described as company philosophy statements. These were:

- moving work more accurately from machine to machine;
- making the shop cleaner, more orderly and more pleasant to work in;
- re-arranging motors, pulleys and belts so as to avoid break-downs;
- preventing waste of work, labor and materials;
- prevention of injuries to men while at their work;

## SPICER MANUFACTURING COMPANY, SOUTH PLAINFIELD WORKS

(Spicer Manufacturing Corporation, South Plainfield Works)

HAER No. NJ-144

(Page 18)

“making the shop so efficient, comfortable, healthy, and paying appropriate wages so our men will stay with us a long time and help to a mutual success by their active co-operation and loyalty” (Spicer Manufacturing Corporation 1917a)

The firm instituted a free, monthly company newspaper called *The Drive Shaft* early in 1917, to “..cement a feeling of mutual good will among the workers. The paper solicits employee contributions of news, gossip, social happenings, sales, and humor.” By this time, a modest company health insurance plan was also provided to employees (Spicer Manufacturing Corporation 1917a). In an attempt to educate its employees about worker injuries and their prevention, each edition of *The Drive Shaft* included a “Safety Column” which included a policy statement followed by an inventory of the injuries and their causes suffered by workers the previous month. Each injury cause and description entry also included a statement on how to prevent the injury. The establishment of a New Jersey State Workman’s Compensation law strengthened company incentives to reduce injuries (Spicer Manufacturing Corporation 1918c).

Beginning in June 1920, the SMCorp established, maintained, and subsidized a free Plant Hospital at the factory on June 14, 1920, in association with Muhlenberg Hospital, a local health care facility. The hospital treated not only work-related injuries of company employees but was open to all local residents to treat all ailments. Between 1,000 and 1,200 people each month were treated at the company hospital. The firm also hired a company nurse, referred to as a “Welfare Nurse”, and provided her with a new car to tend to sick and injured workers at their homes. While the company obviously had an interest in ensuring that its skilled work force return to their jobs as soon as possible, the hospital and visiting nurse likely were a great benefit to the Spicer people (Spicer Manufacturing Corporation 1920e).

Beginning in late 1917, Spicer began furnishing to all its employees, following one year of employment, a graduated group life insurance policy. The company paid all the premiums and fees. The policy initially had a death benefit of \$500.00 that increased by \$100.00 for each year an individual worked for the company. The death benefit increased to a maximum of \$1,500.00 after an individual worked for the company for ten years. The reason the insurance was provided to the employees, according to a company statement, is that it was the firm’s policy “to do everything in their power to relieve a man from worry.” The program, according to the same company statement has “worked out very satisfactorily” (Spicer Manufacturing Corporation 1918c).

The SMCorp constructed for its employees at least ten 6-room row houses, each on one-third acre lots, on Lakeview Avenue, and possibly elsewhere, in South Plainfield in 1917 within walking distance of the plant. The Lakeview Avenue neighborhood came to be known as “Castle Gardens.” Each house and property cost \$3,000.00 with the low price reportedly made possible by the careful purchasing of lumber and material by the SMC (Spicer Manufacturing Company (Spicer Manufacturing Corporation 1918a). Employees who purchased houses could pay for them through overtime wages. One example may still exist on Church Street near the entrance to Veteran’s Park (Spicer Manufacturing Corporation 1917a, 1918c; Randolph 1989).

Beginning in December 1918, with the end of World War I, the SMCorp began to procure miscellaneous lots of surplus Government property for resale to employees at considerable savings. Company representatives visited numerous Government warehouses in the region to determine what material was available. The items identified for purchase, and eventual re-sale to employees, included dishes, knives, forks, spoons, porch furniture, couches, cots, army blankets, mattresses, and groceries. The groceries consisted of canned peas, canned corn, canned tomatoes, canned cherries, dried beans, rice, cocoa, pepper, and Karo syrup. The

## SPICER MANUFACTURING COMPANY, SOUTH PLAINFIELD WORKS

(Spicer Manufacturing Corporation, South Plainfield Works)

HAER No. NJ-144

(Page 19)

Company reportedly purchased the material in bulk with at least some acquired by the “car load” or by the “freight car load.” The company also was attempting to acquire large loads of coal for resale to its employees. By early 1918, the SMCorp had established a co-operative store for its employees. The food re-sale efforts also involved bulk buying or special arrangements with local or regional farmers, as well as clothing purchases. Apparently sales of goods to employees increased rapidly over the years as retail prices increased (Spicer Manufacturing Corporation 1918c, 1918d, 1920c; Randoph 1989).

The influenza pandemic of 1918-1919 greatly affected South Plainfield and the SMCorp work force. The crowded condition of the factory floor was an ideal setting to spread the contagion. Out of 1,700 employees at the time, 10 workers and 36 family members died of the disease while an additional 316 workers and 198 family members became ill. An additional 58 people developed pneumonia. To combat the deadly disease, the SMCorp contacted H.K. Mulford, Inc., the producer of the newly developed influenza vaccine, and acquired more than 1,000 doses to inoculate its workers, their families, and other South Plainfield citizens free of charge. The inoculations were performed in part at the company hospital and reportedly reduced to almost zero the incidents of disease at the plant. To treat those already ill, the firm purchased a car and hired another nurse to call upon the sick. The nurse reportedly made close to 3,000 calls to those ill during the weeks the pandemic raged. That apparently was still not adequate to meet the need. Accordingly, the company urged its workers to call upon one or two sick people in their neighborhoods, furnishing them with the names and addresses of those people. The success of the Spicer effort caused other local industries to develop similar inoculation programs. The demand for the vaccine nation-wide being so great, it reportedly took a trip to Philadelphia to meet Mr. Mulford personally by Clarence Spicer, as well as a certified check, to acquire the large stock of vaccine quickly (Spicer Manufacturing Corporation 1918d; *Plainfield Daily Record* 1918).

Under Charles Dana, SMCorp employee benefits also included several financial programs designed to retain and reward the most skilled workers. To encourage its employees to work towards a college education, in 1920 the firm arranged with the International Correspondence School of Scranton, Pennsylvania to provide a 20% discount from their tuition for four years for company people. The only requirements to enroll were the ability to read and write English and a mastery of the multiplication tables. The company encouraged its workers to enroll with the hope of company advancement stating “The man who is willing to spend a few hours a week in the study of a chosen trade or profession is the kind of man the company is looking for when promotions are in order” (Spicer Manufacturing Corporation 1920e). In 1925, the company began to provide cash awards to workers whose suggestions were implemented (Dana Corporation 2004). Dana also began a Preferred Stock purchase plan for employees in 1920, designed to raise capital for the company as well as stimulate employee productivity and loyalty to the firm (Dana 1920).

### **World War I and the Liberty Truck**

As early as 1904 tests were made of 1.5-ton trucks at the West Point Military Academy with occasional use by the US Army after 1907. In 1914 the Society of Automotive Engineers (SAE) formed a committee to aid the War Department to motorize its’ supply trains. In early 1916 the Army asked the SAE for revised specifications on 1.5 and 3 ton trucks. Army use of motorized trucks began in earnest during the 1916 punitive expedition into Mexico in search of Pancho Villa. The Quartermaster Corps (the Corps) sent out an appeal for trucks (the Mexican Government having refused the use of their railroads) resulting in multiple manufacturers sending down around 2500 vehicles. Experience with the 128 different models subsequently showed the need for a standardized model to reduce parts inventory. In April 1917 the Motor Transport

## SPICER MANUFACTURING COMPANY, SOUTH PLAINFIELD WORKS

(Spicer Manufacturing Corporation, South Plainfield Works)

HAER No. NJ-144

(Page 20)

Board of the War Department issued standard specifications for two classes of trucks, and in May 1917 the Corps decided on three types of vehicles: AA with .75 to 1 ton capacity, A with 1.5 to 2 ton capacity, and B with 3 to 5 ton capacity. With the commencement of American involvement in the war at this time, the Corps had to buy many makes to supply the American forces build-up in France, but work continued on the standardized models with a concentration on the heavier model which came to be known as the Quartermaster Standard B or the Standardized B (Crowell 1919: 496-8.; Crowell and Wilson 663-667).

In June 1917, engineers from truck building companies and component manufactures met with a representative from the Quartermaster General's office. The engineers were organized in groups (e.g., chassis, transmission, axles, universal joints, etc) which probably echoed previously-established SAE groups (Myers 1917: 29, 37; Society of Automotive Engineers 1917a: 87). At a meeting in Columbus, Ohio in July 1917, the war department announced the decision to build standardized trucks with total parts interchangeability. The design work was begun by the SAE Truck Standards Division which drew up specifications with input from the Motor Transport Board. Various divisions within SAE such as Rims, Springs, etc gave advice. In August a group of 50 engineers from the auto industry met in Washington in August 1917 under the supervision of Col. Chauncey B. Baker, Q.M.C. , who later stated later that the SAE designed the B truck (Hardy 1917: 317). Clarence Spicer played a role in this process, among many other engineers. His name does not appear in committee and group lists published by the SAE, but he appears in a large group photograph of participating engineers, and there was a Universal Joints Group in which he must have had a major role (Society of Automotive Engineers 1917a: 88, 1917b: 177, 293)\*

The Army allocated \$175,000 for B truck design work, much of which was completed by September 1917. The industry head of the actual construction project was Christian Girl of the Standard Parts Company and included men from Pierce-Arrow, Premier Motor Company, Mitchell Motors Company, Miller-Franklyn company and others. That committee allocated contracts for parts and chose 29 truck factories as assemblers. Two sample trucks were completed and exhibited on the White House grounds in October 1917. At the time, the project was considered almost as well known as the design and production of the Liberty aircraft engine and the truck was often called the "Liberty" truck. Some 43,000 trucks were ordered, with almost 10,000 produced before, and over 7,000 after, the armistice with the last orders cancelled. Although almost 8,000 were shipped over seas, critical shortages in ocean transport and logistical problems at French ports may have delayed many from actually serving on the front. Even during the height of production and shipping, other branches of the military ordered off the shelf models from many manufacturers. Design work started on the class A and class AA trucks, but few of the former and none of the latter were delivered. The Ordnance Department also designed a four-wheel drive T type "Militor" for towed artillery of which only a few samples were produced. These models may also have had Spicer input in design and supply (Society of Automotive Engineers 1917b: 173, 1917c: 292; Claudy 1917: 330; Eustis 1918; Crowell 1919: 502-4, 586; Crowell and Wilson 1921: 668-9).

The drive system of the Standard B was dictated by the "midship" location of the transmission gearbox behind the cab (Copland 1917: 37) Due to built-in flexibility in the frame, a short "front" universal shaft was required between the engine and gearbox, followed by a longer "rear" shaft to the rear driving axle (Myers 1917: 29). A photograph at the South Plainfield Works on page 7 in the December 1918 edition of the Spicer Manufacturing Corporation's *Driveshaft* company newsletter shows both the front and rear shafts ready for

---

\* Two of the engineers in the photo Alexander T Brown and W. C. Lipe had transmission component companies that eventually ended up as brand names in the Dana owned Spicer Organization (Spicer 1939: 25)

## SPICER MANUFACTURING COMPANY, SOUTH PLAINFIELD WORKS

(Spicer Manufacturing Corporation, South Plainfield Works)

HAER No. NJ-144

(Page 21)

shipment. Other drawings and photographs show what appear to be the distinctive bowl-shaped dust covers used by Spicer on his type G joint, although the Merchant and Evans Company joint used a very similar dust cover (Myers 1917: 30; Claudy 1917: 33; Society of Automotive Engineers 1920: 61, 1926: 9). While the propeller shaft design may have been completely or partially taken from those of Spicer, it is unlikely that Spicer Manufacturing Corporation was the sole supplier. The War Department specifically wanted three or four sources of each part to insure continuity of supply, resulting in over 150 suppliers (Crowell 1919: 498; Crowell and Wilson 1921: 669). Apparently, designers of specific parts shared ideas willingly, and waived their patent rights to help the war effort and the issues were to be settled after the war when it was expected that the truck would be made commercially (Hardy 1917: 308). These agreements are probably in the National Archives and may provide confirmation of Clarence Spicer's contribution to the design and supply of wartime universal joints and shafts.

In spite of the intense effort of the SAE, pressure from the War Department, and apparent "patriotic" efforts of the builders, there may have been opposition to the concept from the builders themselves, some of whom felt it would have been better to field then-current models rather than wait for a standardized one (Eustis 1918). Military planners expected a major campaign in the spring of 1919, which would have allowed plenty of time to field the trucks; the rapid collapse of the German Army in November 1918 was unexpected (Crowell 1919: 13). Some truck manufacturers may have believed that the B truck was mis-engineered as a result of the off road (or no road) experiences in Mexico., since a vehicle designed for decent roads might have served better overall. These firms may also have been worrying about the effects on their post-war business when the Liberty Trucks would ultimately be sold on the commercial market, but the trucks were in such demand by other branches of the government that few were sold as surplus, probably limiting post-war impacts on new truck sales (Crowell and Benedict 1921: 286).

### **Plant Design, Development, and Production Organization\***

When Clarence Spicer moved his factory to present South Plainfield in 1910, industrial architectural and engineering options were evolving rapidly, allowing him to take advantage of some design choices which would have been uncommon or unavailable to him a few years earlier during the beginnings of his manufacturing career. In particular, the more widespread use of reinforced concrete, steel sash, and electric power for "group drive" line shafting after c1905-1910 enhanced opportunities for fire-proof, vibration-resistant factories with extensive natural lighting, and relatively flexible operation of related machine tools on short sections of line shaft. Other common factory designs developed in the late 19<sup>th</sup> century, including steel-framed machine and forge shops with clerestory or sawtooth monitors, were by Spicer's day well-established means of rapidly erecting wide, single-story brick-walled spaces for reduced vibration, better ventilation and machine arrangement, and north-facing light provided by sawtooth roofing where needed for precision operations in the wider spaces. The South Plainfield Works as developed by the early 1920s included a wide range of these designs, as well as earlier industrial building forms. Like many other contemporary makers of precision metal products, however, the managers of this site were less able to introduce mechanized materials-handling systems, inhibiting efficiency despite a number of Clarence Spicer's manufacturing innovations and the general availability of special-purpose machine tools. This problem was exacerbated by the incremental expansion of the plant tied to rapid periods of company growth, which precluded large new shops better suited to enhance production flows. Instead, field documentation in 2006-

---

\*The building numbers used in this documentation correspond to those assigned by the Spicer Manufacturing Corporation no later than the early 1920s, as shown on the only known plans with building numbers made between 1910 and 1929 (Figures 6, 10-11; Spicer Manufacturing Corporation 1926, Day 1929).

## SPICER MANUFACTURING COMPANY, SOUTH PLAINFIELD WORKS

(Spicer Manufacturing Corporation, South Plainfield Works)

HAER No. NJ-144

(Page 22)

2007 and historical maps suggest that production flows degraded by 1920 as numerous new structures were erected. These problems probably contributed to the decision to move all company manufacturing to Toledo by 1926, and as discussed below the Toledo plant opened in 1928 may have been designed in response to the production issues encountered in South Plainfield (Biggs 1996: 23-4, 48-50, 76-91; Bradley 1999: 111, 144-7, 192-3).

Beginning in the 1870s, industrial engineering grew as a profession providing factory designs, cost control systems, worker incentives, and equipment arrangements to enhance work flows and profits. There is no evidence in materials reviewed for this documentation that Clarence Spicer or anyone else in the firms operating the South Plainfield Works engaged such consultants, or that any professional architects worked on any of the buildings. With the likely exception of the powerhouse first built c1914-16 and enlarged in 1918 (Building 9, HAER No. NJ-144-J), and perhaps some of the architectural treatment of the first machine shop (Building 1, HAER No. NJ-144-A), Spicer himself was probably heavily involved in building design decisions. Because of constraints of plant real estate and perhaps finances, there was probably limited planning for expansion during initial plant construction c1910-1912. A lack of flexibility in later work arrangements and increased costs in materials handling, as suggested by evidence assembled for this documentation, appears to make the South Plainfield Works an example of the factory design problems noted in early 20<sup>th</sup>-century industrial engineering literature (cf. Biggs 1996: 48-50).

The plant as initially built was well situated to receive materials and ship products, located within a narrow 2-acre strip of farmland along the Lehigh Valley Railroad, between present-day Hamilton Boulevard and Bound Brook. Continuing the manufacturing and quality controls he gradually established at his earlier operations, Clarence Spicer built at least three major structures by 1912: a reinforced-concrete die sinking shop to create the steel dies needed for drop forging, stamping, and drawing operations (Building 8, HAER No. NJ-144-H); a metal-framed, metal-sided forge building with the drop forges used to rough out universal joint yokes and journals (Building 7, demolished by 1947); and a large steel-framed, sawtooth-roof brick machine shop in which all other administrative, assembling, and metalworking operations were probably located (the northeast half of Building 1, HAER No. J-144-A). The forge and an adjacent sheds probably included facilities for trimming and sandblasting forged parts, and perhaps for heat treating. The machine shop as first built probably accommodated a wide range of work including stamping and drawing casings and springs from sheet metal, grinding of forged parts, broaching of slip joints, drawing and cutting steel shafts, and welding. These structures were spaced relatively far apart, perhaps reflecting Spicer's intent to expand them or add new buildings, but probably requiring wagon or wheelbarrow transport of tools or partially-finished work among the three main structures. By 1913, when he had some 240 employees, Spicer added a metal-sided heat treating building (Building 4, expanded c1914 and demolished by 1947), may have expanded the machines shop by 40 feet, and built another reinforced-concrete structure near the railroad for receipt and inspection of some materials (Building 3, HAER No. NJ-144-E). These were the last structures completed before the success of his products created more pressure for money and facilities than Spicer could sustain on his own (Table 1; Figures 6-7; Ryno 1912; Spicer Manufacturing Company 1913; Spicer Manufacturing Corporation n.d., 1920a).

The first phases of plant construction were characterized by well-built structures of steel, brick, and concrete with extensive steel sash, and by the almost complete absence of timber or temporary buildings. The reinforced-concrete buildings were typical of transitional concrete construction during the decade after c1905 when flat floor and roof slabs were first cast integral with columns, allowing the elimination of the deep beams seen in Building 8 and somewhat more dramatically in Building 3 (Lesley 1907; Gordon and Malone

## SPICER MANUFACTURING COMPANY, SOUTH PLAINFIELD WORKS

(Spicer Manufacturing Corporation, South Plainfield Works)

HAER No. NJ-144

(Page 23)

1994: 334, 380). The machine shop — which may have also included the lunchroom shown on a 1926 plan — used the most expensive form of framing and roofing, relative to flat roofs or clerestory-style monitors, to provide the best lighting to the wide space.\* Located closest to both the railroad and a public street, the c1910-1913 machine shop was also the only building at the plant provided with non-functional architectural treatment to convey an established business presence and hide the jagged if practical appearance of the sawtooth monitors. The latter embellishments included parapet walls along the street end of the monitors, and a painted cornice along the railroad pronouncing to the world that this was the home of SPICER MFG CO. SOUTH PLAINFIELD, N.J. UNIVERSAL JOINTS (Figures 6-8; Spicer Manufacturing Company 1913, 1915).

The most striking facility not present was a power plant, requiring purchase of power for lights and line shafting from public electric utility lines via an on-site transformer, other power sources such as small boilers and/or steam engines for the forge shop, and undocumented means of heating the plant. Increased demands for power to expand manufacturing were probably a factor in the company's extreme difficulties by late 1913 (Figure 7).

With the 1914 mortgage and the beginnings of Charles Dana's administrative controls, the company immediately began an approximately two-year expansion which contributed to rising net earnings by the end of 1916. Additional land was purchased adjacent to Spicer's 1910 tract, in one or more transactions. There was no major re-working of existing facilities to streamline work flow or enhance manufacturing flexibility needed to respond to increased orders from different customers. The general spatial pattern of expansion was to erect new structures further from the railroad, parallel to the first factory buildings, with the manufacturing facilities creating a series of rectangular blocks separated by narrow alleys and served by new rail spurs. Non-manufacturing facilities, notably a powerhouse (Building 9, HAER No. NJ-144-J), were built away from the machine, forge, and heat-treating shops at the northeast end of the expanded property. Historical photographs and maps indicate this program included some wood-framed and steel-framed metal-sided sheds, quickly replaced in some cases by new steel-framed brick structures with generally less-costly roof systems than the first machine shop (see HAER No. NJ-144-A). Two new steel-framed brick machine shops with low gable roofs were built to house stamping, broaching, and clutch-making operations (Buildings 2 and 6, HAER Nos. NJ-144-B and NJ-144-F; see Table 1). These shops allowed for expansion of other grinding and shaft-making operations in Building 1, but separated sequential machining stages among buildings and required more movement of parts and materials. The location of final assembly work in this period is not documented. Building 1 was expanded significantly, in several rapid stages, with a small office block and a second sawtooth-roof machine shop area adjacent to, and as wide as, the c1910-13 structure. The use of the more expensive roof system for the later Building 1 machine shop area may reflect the replacement of the original southwest machine shop wall with a windowless concret-block partition, requiring enhanced natural shop lighting. The wall, penetrated by two openings, evidently divided operations within some machining departments, which may also have increased materials handling time (Figures 6, 8; Table 1; Spicer Manufacturing Company 1915; Dunham-Clarín Company 1917).

Among the earliest and perhaps most important of the c1914-1916 buildings was the powerhouse built just southwest of the die sinking shop away from the manufacturing operations. Coal-fired boilers powered stream turbine-generator units, which used condensing water supplied by a pond created on Bound Brook.

---

\* Framing, flashing, and gutter requirements made a sawtooth roof far more expensive than flat roofs without skylights or roofs with central monitors (Bradley 1999: 193).



## SPICER MANUFACTURING COMPANY, SOUTH PLAINFIELD WORKS

(Spicer Manufacturing Corporation, South Plainfield Works)

HAER No. NJ-144

(Page 24)

The powerhouse also included an air compressor installed sometime before 1929 (Day 1929). The turbine-generators provided AC power which was distributed through a switchboard to the rest of the plant for lighting, machine tool driving, electrical welding and either heat treating, forge heating or both. In addition to providing electrical power and compressed air, the boilers also fed an extensive network of undocumented underground steam pipes to other plant buildings. Some of the power was probably converted to DC for manufacturing operations such as running variable-speed motors for line shafting or perhaps some individual machines, although power distribution arrangements at the plant are not well documented. Several historical photographs show a large electrical conversion at an undetermined location. Given the expense of transmitting DC over any distance, it made sense to convert to DC in a substation close the main work centers. The photographs of the substation show many motor generators which would have been the preferred conversion device for factories of the period. In addition to numerous smaller machines, there were two large sets, one of which appears to have been converted from a three-bearing belt-driven generator. That modification, and the carrying of banded generator leads to the ceiling and over to the switchboards (instead of installation in underfloor ducts) shown in some photographs may suggest a hastily-installed facility during rapid plant expansion, but may also reflect an attempt to enhance flexibility in machine placement more fully realized in the Toledo plant as described below.

The financial success of the c1914-1916 expansion program replicated problems Clarence Spicer faced in 1913: the plant continued to receive new business which overextended the company's ability to meet demand. The 1917 corporate reorganization to raise additional capital led to a third phase of plant expansion lasting until c1919-1920, which was associated with the rapid drive to produce propeller shafts for the Class B Liberty truck during World War I.\* This expansion included upgrading or enhancement of some existing facilities, and construction of at least seven new buildings and one building addition. Upgrading included enlargement of the forge shop, heat-treating building and the powerhouse, the installation of a laboratory probably in Building 3 to check the quality of all steel delivered to the plant. New buildings included a maintenance and millwright structure to support expanded manufacturing (Building 5, HAER No. NJ-144-I), a trim shed to replace facilities probably lost when the forge shop was enlarged (Building 17, HAER No. NJ-144-K), a welding building soon flanked by a shipping building and an assembly building (Buildings 14-16, HAER NO. NJ-144-C), an oil house to store cutting and lubricating fluids for machining operations (Building 24, HAER No. NJ-144-G), and a storage and garage structure also housing a small experimental department (Building 28, HEAR No. NJ-144-D). An addition to Building 2 accompanied construction of Building 16 to facilitate movement of finished shaft and joint components into assembly areas. The spatial pattern of the c1917-1920 expansion was similar to that of c1914-1916, with manufacturing facilities (Buildings 14-17) built nearest the existing shops, and maintenance or support structures (Buildings 5, 24, and 28) built further away. In contrast to the previous phases of construction, however, most of the new buildings were notable for their use of wood framing and/or metal siding, suggesting an emphasis on faster, cheaper construction. The assembly and shipping buildings were not adjacent to each other. The installation of welding operations in a largely wood-framed structure was especially striking, and required use of metal shields to keep sparks from all-wood sections of Building 14. The larger of the new buildings (Nos. 14, 16, and 28), were equipped with monitors to enhance lighting and ventilation. Transverse monitor placement on Building 28 was relatively unusual, but may reflect a need for ventilation rather than lighting in a non-manufacturing space, and was probably less expensive to build than a clerestory-style monitor such as those in Buildings 14 and

---

\* Although available documents and images leave the dating or sequence of new buildings between 1917 and 1923 somewhat unclear, Spicer Manufacturing Corporation's history during this period makes it unlikely that there was much if any South Plainfield Works expansion c1920-1922. With the possible exception of Building 22 (see HAER No. NJ-144-F), and the known addition of Building 30 c1923-1926 (see HAER No. NJ-144-J), plant expansion was largely complete by 1920 (Table 1).

## SPICER MANUFACTURING COMPANY, SOUTH PLAINFIELD WORKS

(Spicer Manufacturing Corporation, South Plainfield Works)

HAER No. NJ-144

(Page 25)

16. Possibly the last of the plant's manufacturing buildings from the World War I period, only Building 16 was steel-framed with almost all-brick walls (Figures 9-11; Table 1; Dunham-Clarín Company 1917; Spicer Manufacturing Corporation 1918a, 1918b, 1923, 1926).

Aside from a small structure built c1923-1926 for water-softening to control powerhouse feedwater and boiler-water (Building 30, see HAER No. NJ-144-J), the last manufacturing building at the South Plainfield Works was probably Building 22, a steel-framed brick sawtooth-roofed structure built to house additional heat treating and machine operations as well as a service department (Table 1; see HAER No. NJ-144-F). Construction of this shop adjacent to Building 6 (the c1915 stamping building) removed the earlier structure's northeast wall, and left little space between the shearing, heat treating, sand blasting, and blacksmith facilities in Buildings 4, 10, and 21. Building 22, with the more expensive roof design found in the plant's pre-war machine shops, may reflect a slightly more measured pace of construction during the renewed period of company profits beginning c1922 (Figures 11-12; Spicer Manufacturing Corporation 1926).

The continued construction of relatively small additional shops almost certainly aggravated material handling flows. Forgings were moved from the forge shop to the trim shed by wheelbarrow (Spicer Manufacturing Company 1920a: 14). Probably by the end of World War I, electric trucks with trailers were used to move finished or partly-finished components between or within buildings, as indicated by a truck charging station in Building 28. There is no confirmed evidence of mechanical handling systems within buildings. Some machine tools may have had individual motors, but most appear to have remain driven by electric-driven line shafts, which inhibited flexibility if re-alignment of equipment was needed to make different orders. By contrast, the Toledo facility completed in 1928 was evidently designed to maximize flexible manufacture and reduce inter-building transfers:

“The nature of the company's business required major changes in its production lines every four or five months, and lesser changes-involving on the average twenty machines-every week. The plant was housed in a one-story building with monitor roof so constructed as to provide adequate natural light in all parts of the interior, thus imposing no limitations on the location of machines because of light requirements. The factory floor was made of asphalt-impregnated wood blocks over which heavy machines could be slid without injury to them or to the floor. Suspended from the roof at regular intervals were electric power ducts, which could be plugged into at any point. The machines themselves, each driven by an individual motor, got their electric current from the overhead ducts through lead-in wires carried in flexible cable rather than in rigid pipe, as in other plants. This system did not make for tidiness of appearance, but it saved a lot of pipe- fitting time when changes in layout were made. As a result of these various features it was possible for a tractor and its operator and one millwright to haul and shove a machine from one location to another in a very brief time, the electrician merely pulling the plug out of one junction box on the overhead ducts and plugging it into another. A department of fifty machines, many of them heavy gear cutters, was thus moved in a single day by two tractors plus their operators, two millwrights, and two electricians” (Kouwenhoven 1962: 229-30).

Although based on a later description of the plant (Kalleher 1943), Kouwenhoven's description appears to reflect lessons learned from the South Plainfield Works. Some of the Toledo plant features were presaged by partial wood block floors and probable overhead wiring of some individual machines at South Plainfield, but the full advantages of machine-shop precision production possible by 1925 could not be realized at factory with such dispersal of facilities.

**SPICER MANUFACTURING COMPANY, SOUTH PLAINFIELD WORKS**  
 (Spicer Manufacturing Corporation, South Plainfield Works)

HAER No. NJ-144

(Page 26)

**Table 2. MAIN CONSTRUCTION SEQUENCE BY BUILDING TYPE & MAJOR FUNCTION**

	Reinforced Concrete	Wood-Framed Brick, Flat Roof	Steel-Framed Brick, Sawtooth Roof	Steel-Framed Brick, Flat/Low Gable Roof	Steel-Framed Brick, Gable Roof, Partial Monitor	Wood-Framed, Gable Roof	Mostly Wood-Framed, Steel-Framed Full Monitor	Steel-Framed, Metal Sided, Gable Roof, Monitor &/or Ventilators	Steel-Framed, Wood Sided	Concrete/Tile Block
c1910-1912	Bldg. 8: die sinking		northeast half of Bldg. 1: machine shop					Bldg. 7: forge (demolished by 1947)*		
1913	Bldg. 3: receive, store & inspect material							Bldg. 4: heat treating building (demolished by 1947)*		
c1914-1916		Bldg. 1 office		Bldg. 9: power house				Bldg 4 expansion		
c1915		Bldg. 1 office expansion	Bldg. 1 south-west machine shop area	Bldg. 6: stamping; Bldg. 2: machine shop						
c1917-1918							Bldg. 14: welding	Bldg 7 expansion		
c1917-1919						Bldg. 15: shipping				
c1917-1920			Bldg. 22?: machine shop, heat treating, service**			Bldg. 5: maintenance		Bldg. 28: storage, experiments, electric truck charging; Bldg. 24: oil storage	Bldg. 17: trim shed	
1918				Bldg. 9 expansion						
c1918-1920				Bldg. 2 addition	Bldg. 16: assembly					
c1923			Bldg. 22?: machine shop, heat treating, service**							
c1923-1926										Bldg. 30: water softening

\* Building information inferred from historical photographs and bird's-eye views.

\*\* Although most structures built after c1917 probably pre-date the temporary decline of Spicer Manufacturing Corporation business c1920-1921, one historic photograph shows Buildings 14-16 in place or under construction while the site of Building 22 was occupied by a wooden structure. The 1923 movement of Hartford Auto Parts Corporation machinery to the South Plainfield Works, after the 1922 purchase of that company, may have led to construction of Building 22 (Spicer Manufacturing Corporation 1923b)

## **SOURCES OF INFORMATION/BIBLIOGRAPHY**

### **A. Historical Photographs**

In addition to a small number of views published in company newsletters, catalogs, and promotional material, there are a large number of views in the collections of The History Factory, Chantilly, Virginia. The latter consist primarily of interior views, analytical use of which is inhibited by the limited labeling of locations and the admixture in this collection of unlabeled views from what are probably the Toledo, Ohio plant. There are also a few panoramic views of the South Plainfield plant in the collections of The History Center, South Plainfield Historical Society, South Plainfield, New Jersey.

### **B. Bibliography**

Berry, J.S.

- 1929a Bulletin from the Spicer Manufacturing Company, April 1, 1929. J.S. Berry, Manager, Spicer Manufacturing Company. Original in the collections of The History Factor, Chantilly, Virginia. Archive number 11-0-0-6-42.

Biggs, Lindy

- 1996 *The Rational Factory: Architecture, Technology and Work in America's Age of Mass Production*. Baltimore: The Johns Hopkins University Press.

Boesch, Eugene J.

- 2006 Draft Historic Places Significance Evaluation/Operable Unit 2/Cornell-Dubilier Electronics Superfund Site, South Plainfield, NJ. Report prepared for Malcolm Pirnie, Inc.

Bradley, Betsy H.

- 1999 *The Works: Industrial Architecture of the United States*. New York: Oxford University Press.

Claudy, C. H.

- 1917 The Liberty Truck. *Scientific American*. 117, 18: 330, 335. November.

Copland, A. W.

- 1918 Transmissions for the Class B Truck. *The Journal of the Society of Automotive Engineers* 2, 1: 37-39. January.

Crowell, Benedict.

- 1919 *America's Munitions 1917-1918*. Washington: Government Printing Office.

Crowell, Benedict, and Robert F. Wilson

- 1921 *How American Went to War: The Armies of Industry*. Vol. 2. Ch. 32. Vehicles, pp. 662-673. New Haven: Yale University Press.

**SPICER MANUFACTURING COMPANY, SOUTH PLAINFIELD WORKS**

(Spicer Manufacturing Corporation, South Plainfield Works)

HAER No. NJ-144

(Page 28)

Dana, Charles Anderson

- 1920 1920. Notice to the Employees of the Spicer Manufacturing Corporation, South Plainfield, New Jersey. Original in the collections of The History Factory, Chantilly, Virginia. Archive Number 5-4-0-0-1-1 (432).

Dana Corporation

- n.d. The Story of the Dana Corporation. Original in the collections of The History Factor, Chantilly, Virginia. Archive number 2-0-0-4-1.
- 1954 History of the Dana Corporation. Original in the collections of The History Factor, Chantilly, Virginia. Archive number 3-0-0-6-14.
- 2001 When Dana Met Spicer.” Dana Corporation Newsletter: Issue Three. Original in the collections of The History Factor, Chantilly, Virginia. Archive number 2-0-0-4-1.
- 2004 *The Story of the Dana Corporation*. Dana Corporation, Toledo, Ohio.

Day, Joseph P.

- 1929 3 Factories for Sale Formerly Occupied by Spicer Mfg. Co. Joseph P. Day Real Estate Agent, New York, New York. Original in the collections of The History Factory, Chantilly, Virginia. Archive Number 11-0-0-8-4 (827).

Dunham-Clarin Company

- 1917 Map of Property Situated at South Plainfield, Middlesex County, New Jersey, Property of Spicer Manufacturing Corporation, July, 11, 1917. Original in the collections of The History Factory, Chantilly, Virginia. Archive Number 11-0-0-6-3942.

Dyke, A.L.

- 1919 Dyke’s Automobile and Gasoline Engine Encyclopedia. Tenth edition. St. Louis: A.L. Dyke.

Eustis, John, R.

- 1918 The Abandoned Liberty Trucks. *The Independent*. May 18.

Gordon, Robert B., and Patrick M. Malone

- 1994 *The Texture of Industry*. New York: Oxford University Press.

Hardy, C. H.

- 1917 The New War Truck. *Scientific American* 117, 16: 308, 317. October.

Industrial Directory of New Jersey

- 1907,  
1909,  
1912,  
1915,  
1927 Industrial Directory of New Jersey Plainfield (H 4), Union County. Original in the collections of the New Jersey Archives, Trenton, New Jersey.

**SPICER MANUFACTURING COMPANY, SOUTH PLAINFIELD WORKS**

(Spicer Manufacturing Corporation, South Plainfield Works)

HAER No. NJ-144

(Page 29)

Kallaher, Mike

1943 How to Change Layouts Often. *Factory*, March 1943.

Kouwenhoven, John A.

1962 *Made in America: The Arts in Modern Civilization*. New York, Anchor Books.

Lesley, Robert W., comp.

1907 *Concrete Factories: An illustrated review.....* New York: Bruce & Banning for Cement Age Company.

McPherson, Rene C.

1973 Dana, Towards the Year 2000. Address given to the Newcomen Society in North America,

Merchant & Evans Company.

1920 Universal Joint for Oil and Grease Lubrication. *The Journal of the Society of Automotive Engineers*. (advertisement) 7, 6: 61. December.

Myers, Cornelius T.

1918 Chassis Design of the Class B Motor Trucks. *The Journal of the Society of Automotive Engineers*. 2, 1: 29-32. January.

*New York Times*

1919 Bought by Spicer Company. October 5.

1922 Spicer Plant Working at Capacity. September 20.

*Plainfield Courier News*

1914 Spicer Company to Expand. February 16. Original in the The collections of the History Factory, Chantilly, Virginia. Archive Number 5-4-0-11-12 (529).

1919 Spicer Company Buys Two Big Industries." October 5. Original in the collections of The History Factory, Chantilly, Virginia. Archive Number 5-4-0-11-12 (529).

1929a Spicer Workers are Taken West in Special Car." February 1. Copy in The History Center, South Plainfield Historical Society, South Plainfield, New Jersey.

1929b South Plainfield Spicer Plant Not to Close." February 2. Copy in The History Center, South Plainfield Historical Society, South Plainfield, New Jersey.

*Plainfield Daily Record*

1918. Spicer Corporation's Use of Vaccine Big Factor in Causing Abatement of Influenza Epidemic. November 1. Copy in The History Center, South Plainfield Historical Society, South Plainfield, New Jersey.

**SPICER MANUFACTURING COMPANY, SOUTH PLAINFIELD WORKS**

(Spicer Manufacturing Corporation, South Plainfield Works)

HAER No. NJ-144

(Page 30)

Randolph, Larry

- 1989 Industry's Role in Town's Growth. South Plainfield Reporter, April 27. The History Center, South Plainfield Historical Society, South Plainfield, New Jersey.

Ryno, Lewis

1912. Sketch Map of the Spicer Facility at South Plainfield. In Farm Accounts Book of Lewis Ryno for the years 1882 – Post 1912. Original in the Special Collections of Rutgers University, Alexander Library, New Brunswick, NJ.

Society of Automotive Engineers

- 1917a Standardization of Assembled Military Truck Parts. Military Truck Conferences. *The Journal of the Society of Automotive Engineers* 1: 187-88. July.
- 1917b The Building of the United States Military Truck. *The Journal of the Society of Automotive Engineers* 1, 3: 173-177. September.
- 1917c Detail of New War Trucks. *The Journal of the Society of Automotive Engineers* 1, 5: 292-294. November
- 1940 Clarence Winfred Spicer. S.A.E Journal. 46, 1: 20-21. January

Spicer, C.W.

- 1903 Casing for Universal Joints. U.S. Patent 728779.
1926. Action, Application and Construction of Universal Joints. The Society of Automotive Engineers, Inc., New York, New York. Original in the collections of The History Factory, Chantilly, Virginia. Archive Number 1-1-1-3-1 (101).

Spicer Manufacturing Company

- n.d. Summary of Minutes of Board of Directors Meetings 1909-1916." Original in the collections of The History Factory, Chantilly, Virginia. Archive Number 5-2-0-2-23 (302).
- 1913 Diagram Showing Location of Watchmen's Keys – Spicer Manufacturing Company. Original in the collections of The History Factory, Chantilly, Virginia. Archive Number 1-2-6-4-1 (504).
- 1915 Bird's Eye View of the Spicer Manufacturing Company." Original in the collections of The History Factory, Chantilly, Virginia. Archive Number 1-5-6-3-1 (741).

Spicer Manufacturing Corporation

- n.d. Spicer Propeller Shafts for Motor Cars. Original in the collections of The History Factory, Chantilly, Virginia. Archive Number 5-3-0-1-6 (401).
- 1917a *The Drive Shaft* I, 2. February. Original in the collections of The History Factory, Chantilly, Virginia. Archive Number 5-4-0-0-1-1(432).

**SPICER MANUFACTURING COMPANY, SOUTH PLAINFIELD WORKS**

(Spicer Manufacturing Corporation, South Plainfield Works)

HAER No. NJ-144

(Page 31)

- 1917b *The Drive Shaft I*, 3. March. Original in the collections of The History Factory, Chantilly, Virginia. Archive Number 5-4-0-0-1-1(432).
- 1918a The Chemical Laboratory. *The Drive Shaft II*, 12: 4-5. December. Original in the collections of The History Factory, Chantilly, Virginia. Archive Number 5-4-0-0-1-1(432).
- 1918b What is a Power House? *The Drive Shaft II*, 12: 4-5. December. Original in the collections of The History Factory, Chantilly, Virginia. Archive Number 5-4-0-0-1-1(432).
- 1918c *The Drive Shaft II*, 1. January. Original in the collections of The History Factory, Chantilly, Virginia. Archive Number 5-4-0-0-1-1(432).
- 1918d *The Drive Shaft II*, 2. February. Original in the collections of The History Factory, Chantilly, Virginia. Archive Number 5-4-0-0-1-1(432).
- 1919 Spicer Universal Joints Catalog No. 13. Original in the collections of The History Factory, Chantilly, Virginia. Archive Number 5-3-0-1-6 (401).
- 1920a Spicer Universal Joints and Propeller Shafts. Original in the collections of The History Factory, Chantilly, Virginia. Archive Number 5-3-0-1-6 (401).
- 1920b Spicer Universal Joints and Propeller Shafts. *Journal of the Society of Automotive Engineers*. (advertisement) 6, 6: 76. June.
- 1920c *The Drive Shaft IV*, 2. February. Original in the collections of The History Factory, Chantilly, Virginia. Archive Number 5-4-0-0-1-1(432).
- 1920d *The Drive Shaft IV*, 4. April. Original in the collections of The History Factory, Chantilly, Virginia. Archive Number 5-4-0-0-1-1(432).
- 1920e *The Drive Shaft IV*, 6. June. Original in the collections of The History Factory, Chantilly, Virginia. Archive Number 5-4-0-0-1-1(432).
- 1923a South Plainfield Works of the Spicer Manufacturing Corporation, South Plainfield, New Jersey. Copy in the collections of The History Factory, Chantilly, Virginia. Archive Number 05050000102021301.
- 1923b Annual Report for Fiscal Year Ending December 31, 1923. Original in the collections of The History Factory, Chantilly, Virginia. Archive Number 6-0-0-1-10 (603).
- 1926 Department and Building Location Plan, Spicer Manufacturing Corporation, South Plainfield, New Jersey. Original in the collections of The History Factory, Chantilly, Virginia. Archive Number 5-4-0-0-(432).



**SPICER MANUFACTURING COMPANY, SOUTH PLAINFIELD WORKS**

(Spicer Manufacturing Corporation, South Plainfield Works)

HAER No. NJ-144

(Page 32)

- 1929a Silver Anniversary Year 1904-1929 – Yesterday. Original in the collections of The History Factory, Chantilly, Virginia. Archive Number 11-0-0-8-4 (827).
- 1929b Silver Anniversary Year 1904-1929 – the Growth of an Idea.” Original in the collections of The History Factory, Chantilly, Virginia. Archive Number 11-0-0-8-4 (827).
- 1939 Reliability. *Journal of the Society of Automotive Engineers*. (advertisement) Vol. 45, 6: 25. December.

Spicer Universal Joints

- 1925 Our Majority. Spicer Manufacturing Corporation. Typescript on file, in the collections of The History Factory, Chantilly, Virginia.

*Toledo Business*

- 1927 Construction on the Dana Manufacturing Company. December 1927: 8. Original in the collections of The History Factory, Chantilly, Virginia. Archive Number 11-0-0-6-6 (826).
- 1928a Announcement by Charles Dana. May 1928: 3. Original in the collections of The History Factory, Chantilly, Virginia. Archive Number 11-0-0-6-6 (826).
- 1928b The Spicer Manufacturing Company.”, December 1928:23. Original in the collections of The History Factory, Chantilly, Virginia. Archive Number 11-0-0-6-6 (826).

Thermoid Rubber Company

- 1920 A five-ton blow on the rear axle - Thermoid-Hardy Universal Joint. *The Journal of the Society of Automotive Engineers*. (advertisement) 7, 6: 29. December.

SPICER MANUFACTURING COMPANY, SOUTH PLAINFIELD WORKS

(Spicer Manufacturing Corporation, South Plainfield Works)

HAER No. NJ-144

(Page 33)

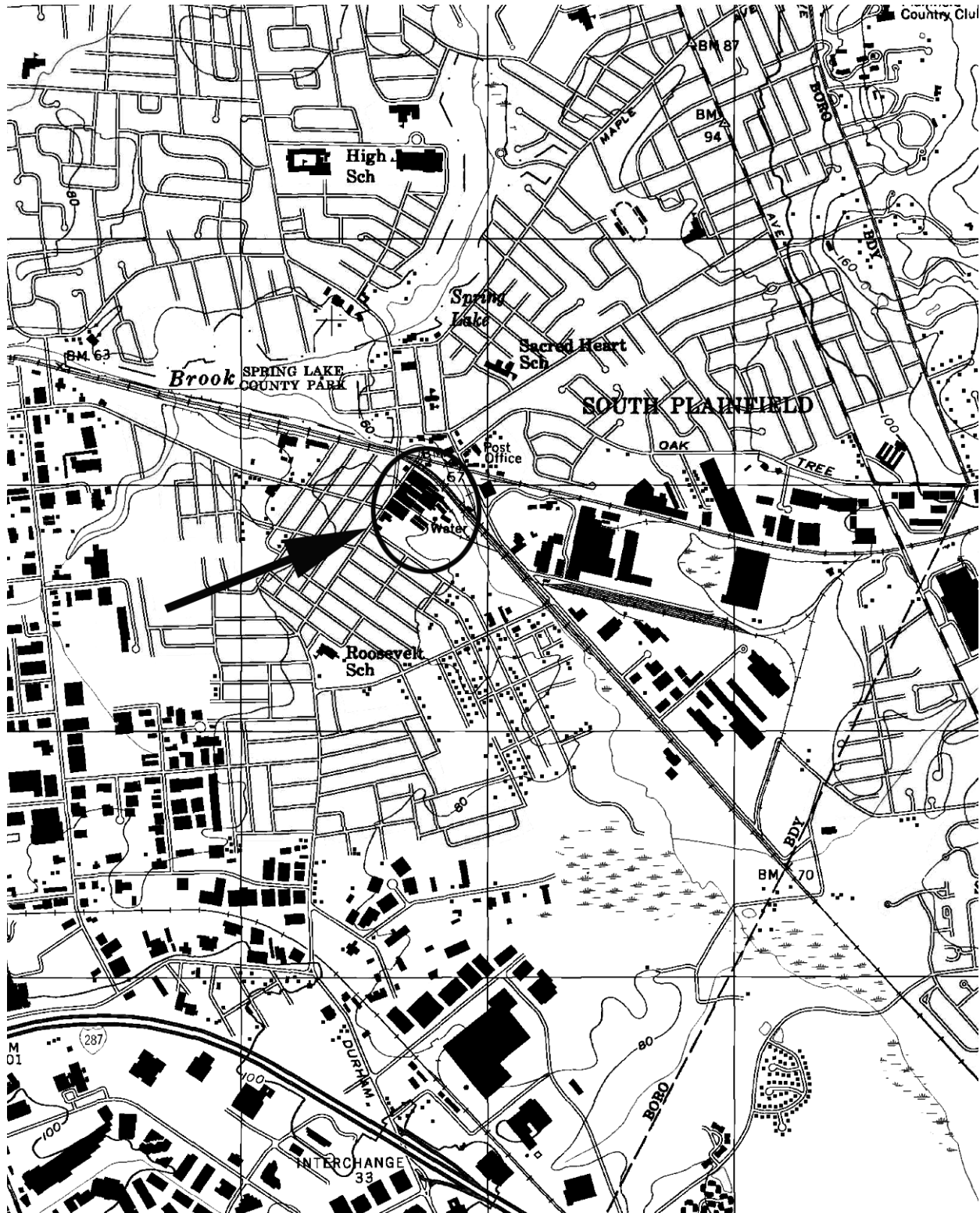
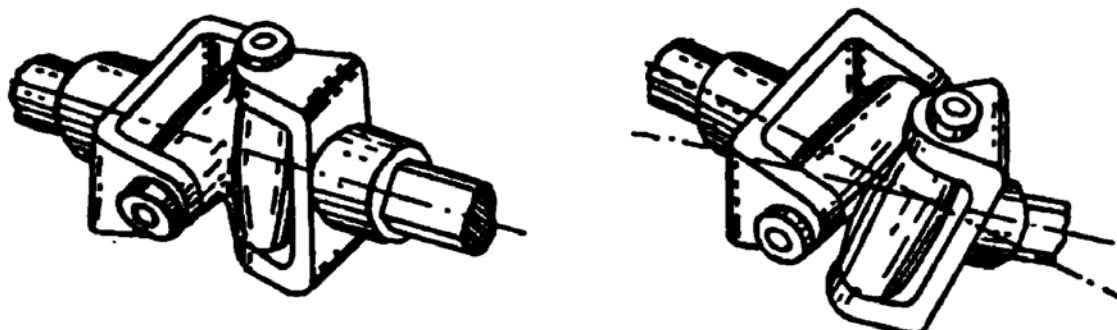

Figure 1. SOUTH PLAINFIELD WORKS LOCATION ON 1995 PLAINFIELD, NJ U.S. GEOLOGICAL SURVEY QUADRANGLE  
scale: 1: 24,000



GENERIC UNIVERSAL OR CARDAN JOINT WITH SHAFTS  
IN AND OUT OF STRAIGHT ALIGNMENT



SCHEMATIC SECTION OF UNIVERSAL JOINT CONNECTIONS  
BETWEEN TRANSMISSION AND REAR AXLE

**Figure 2. GENERIC DIAGRAMS OF UNIVERSAL JOINTS AND AUTOMOBILE PROPELLER  
SHAFT ASSEMBLIES**

(base drawings from Dyke 1919: 43)

# SPICER MANUFACTURING COMPANY, SOUTH PLAINFIELD WORKS

(Spicer Manufacturing Corporation, South Plainfield Works)

HAER No. NJ-144

(Page 35)

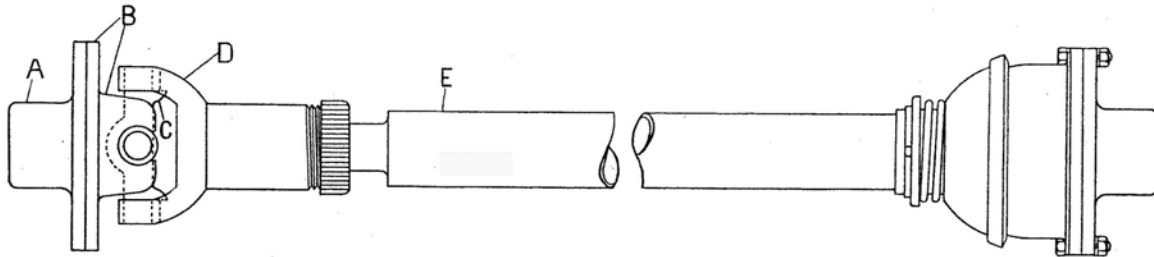

**T**HE Spicer Propeller Shaft is usually made in the form shown here. "A" is the companion flange, which is fitted to the transmission shaft. "B" is the driving flange, which transmits the torque load through the journal cross piece "C" to the splined yoke "D". The torque load at this point is transmitted to the propeller shaft "E" through a multiple spline, having ample bearing surface to permit of free lengthwise movement while carrying full torsional

load. From the propeller shaft, the torque is transmitted to the rear axle pinion shaft through the second universal joint, which is a duplicate of the first, except for the omission of the slip yoke.

While the fundamental principles of the Spicer design are well established and have been tested perhaps by greater mileage than any other unit used in motor cars, refinements are made whenever a better way can be found.

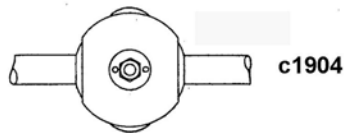

The original Spicer Universal Joint was spherical in appearance and consisted of two similar yokes connected by a single piece journal cross and enclosed in a spherical shell supported by projections on two of the cross journals. This construction presented difficulties in assembling to the car.

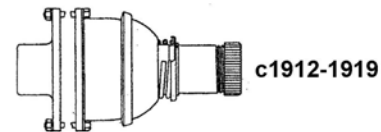

Experience showed that the operator usually neglected to make the necessary adjustment between the two casings to compensate for packing wear, so the threaded nut was discarded and a spring with suitable retainer, that made adjustment automatically, was adopted.

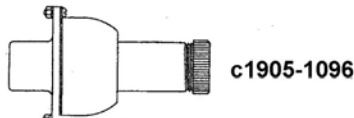

To overcome these, one of the yokes was made in the form of a disc and the shell or casing in semi-spherical form. A telescoping member was added to compensate for shaft length variation incidental to axle movement.

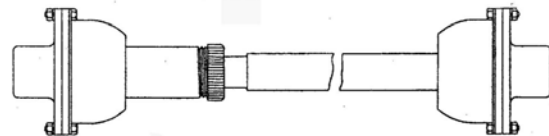

Originally all two joint assemblies were provided with "solid" shafts.

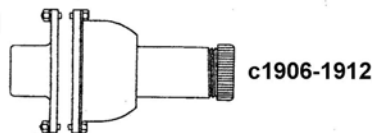

To still further facilitate rapid assembly to the car, the disc form of yoke was made in two pieces; one part, known as the flange yoke, remaining a unit of the joint proper; the other part, known as the companion flange, becoming essentially a unit of the transmission or axle. In this form the propeller shaft, with its universal joint at each end, is a unit complete in itself, and its application is a simple matter of coupling the flanges to the vehicle.

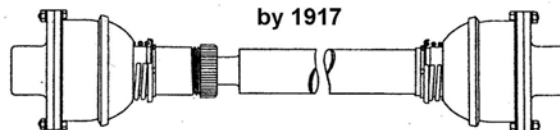

As good roads developed, higher car speed was demanded. This, coupled with the tendency to longer wheel bases and higher engine speeds, introduced the problem of shaft whip.

To meet this condition, the "tubular" shaft was developed. With this construction, because of its extreme lightness, a very much larger diameter is obtainable without increasing the weight. The speed in revolutions per minute at which a shaft of a given length will not "whip" or "whirl" can be increased very materially by enlarging the shaft diameter. The use of tubing permits this increased diameter without corresponding increase in weight.

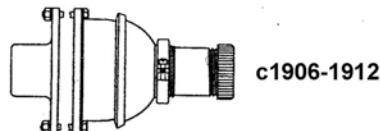

Later, an auxiliary casing was added as a further protection against the entrance of dust or other foreign matter, particularly gritty slush such as is encountered on wet roads. The auxiliary casing was provided with a packing and held in contact with the inner casing by means of a threaded nut.

While the principle and general construction of the Spicer Universal Joint remain the same, refinements are being made from time to time, keeping pace with the increasing demands for higher quality of service required of the motor vehicle. No radical change has ever been found necessary, but the evolution has been constant, and will continue in the future.

Figure 3. SUMMARY EVOLUTION OF SPICER UNIVERSAL JOINTS & PROPELLER SHAFTS c1904-1919

(source: Spicer Manufacturing Corporation n.d.: 10)

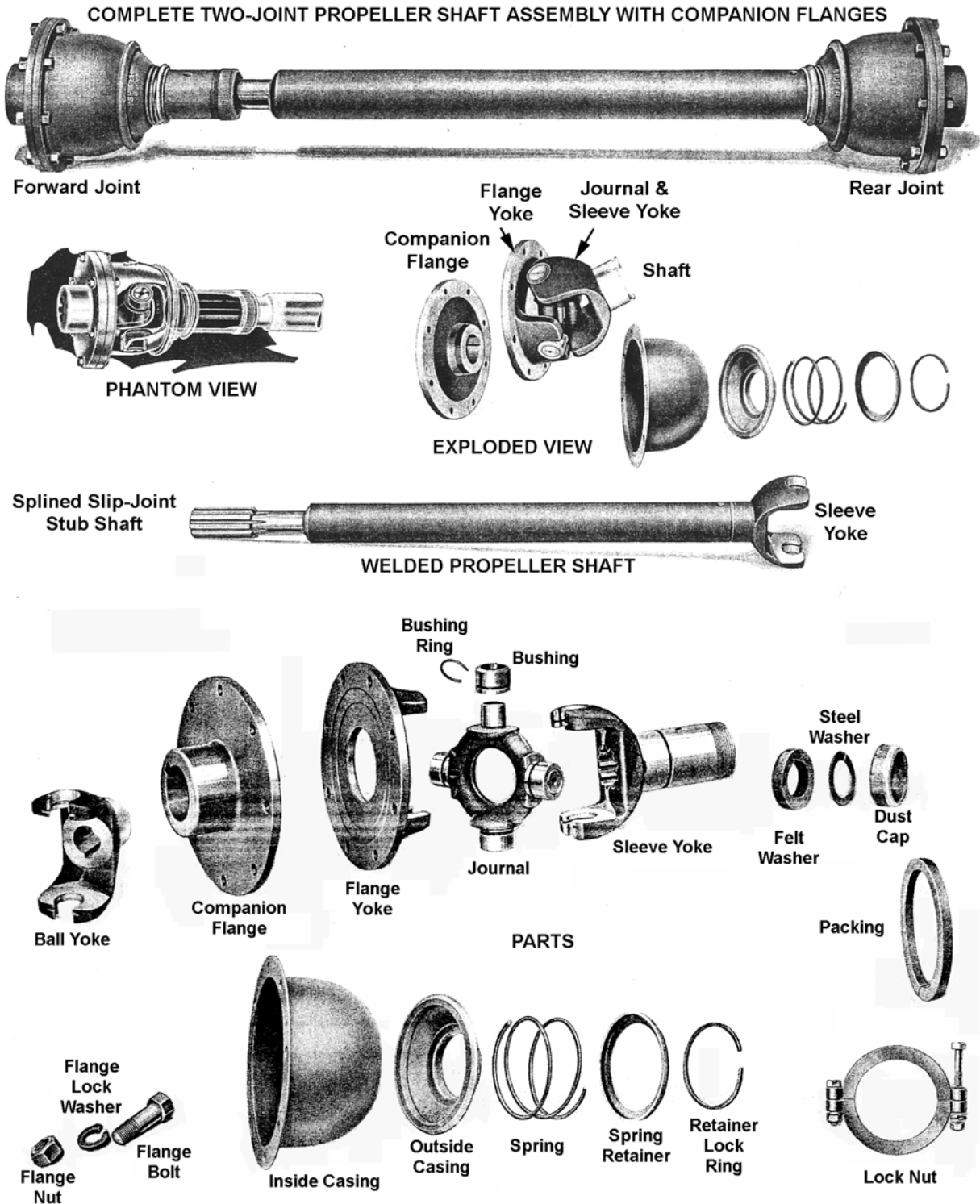

Figure 4. SPICER UNIVERSAL JOINT & PROPELLER SHAFT DETAILS

(source: Spicer Manufacturing Corporation n.d.: 11, 14)

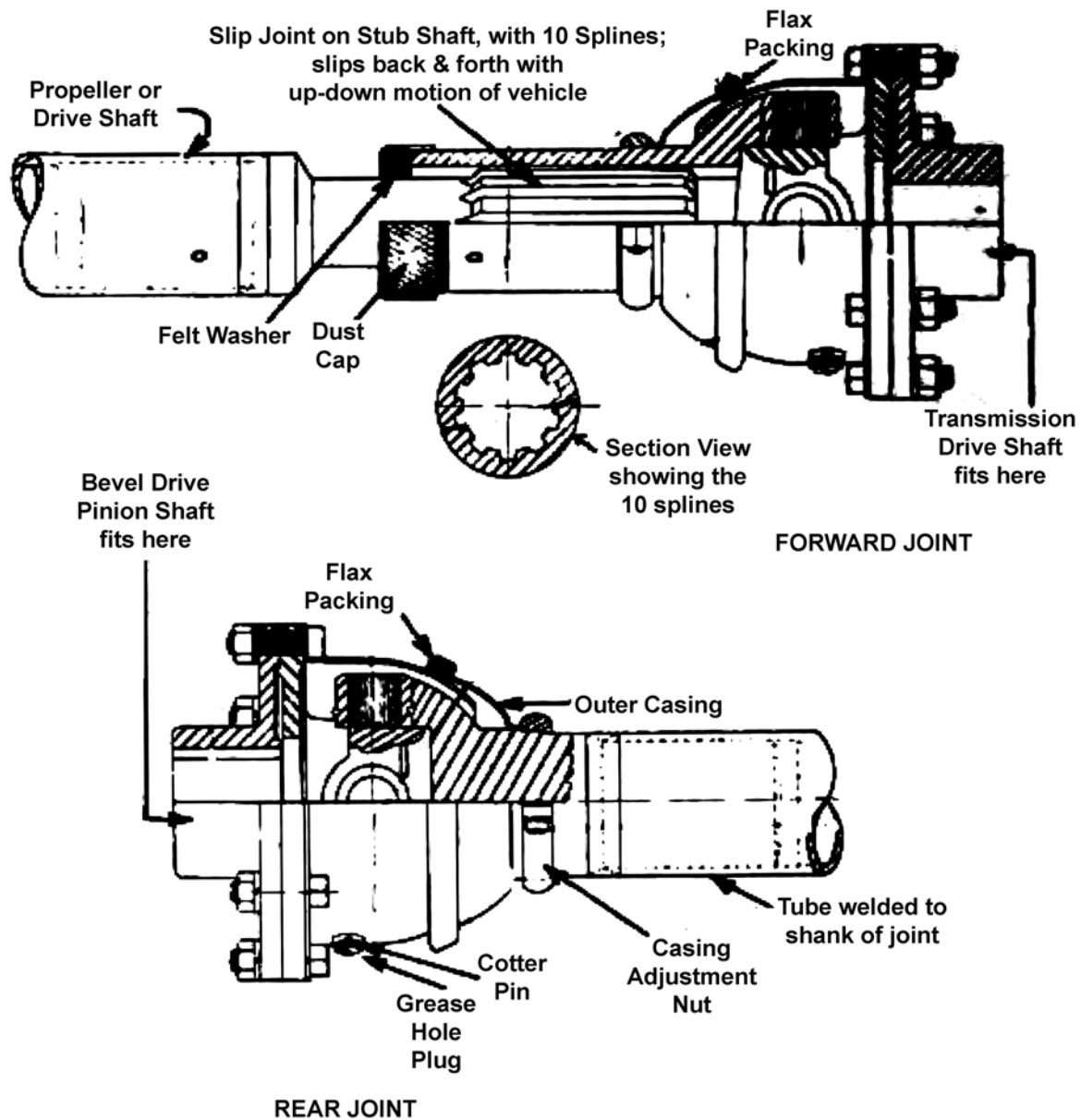
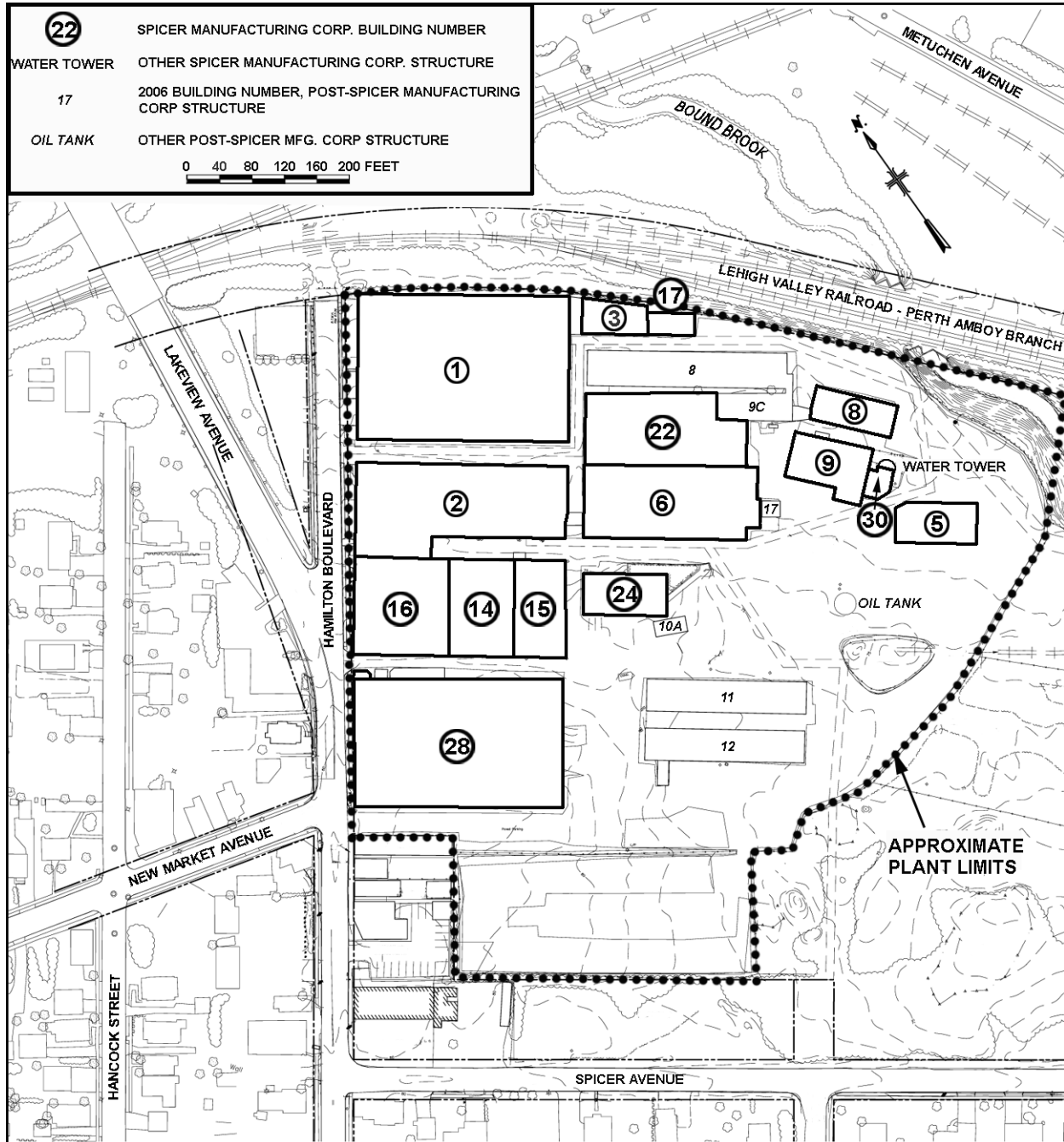

Figure 5. HALF SECTION DETAILS OF SPICER UNIVERSAL JOINTS

(base image: Dyke 1919: 680)

**SPICER MANUFACTURING COMPANY, SOUTH PLAINFIELD WORKS**  
 (Spicer Manufacturing Corporation, South Plainfield Works)  
 HAER No. NJ-144  
 (Page 38)



**Figure 6. 2006 BUILDING LOCATIONS AT FORMER SPICER MANUFACTURING CORP. PLANT**

**SPICER MANUFACTURING COMPANY, SOUTH PLAINFIELD WORKS**

(Spicer Manufacturing Corporation, South Plainfield Works)

HAER No. NJ-144

(Page 39)

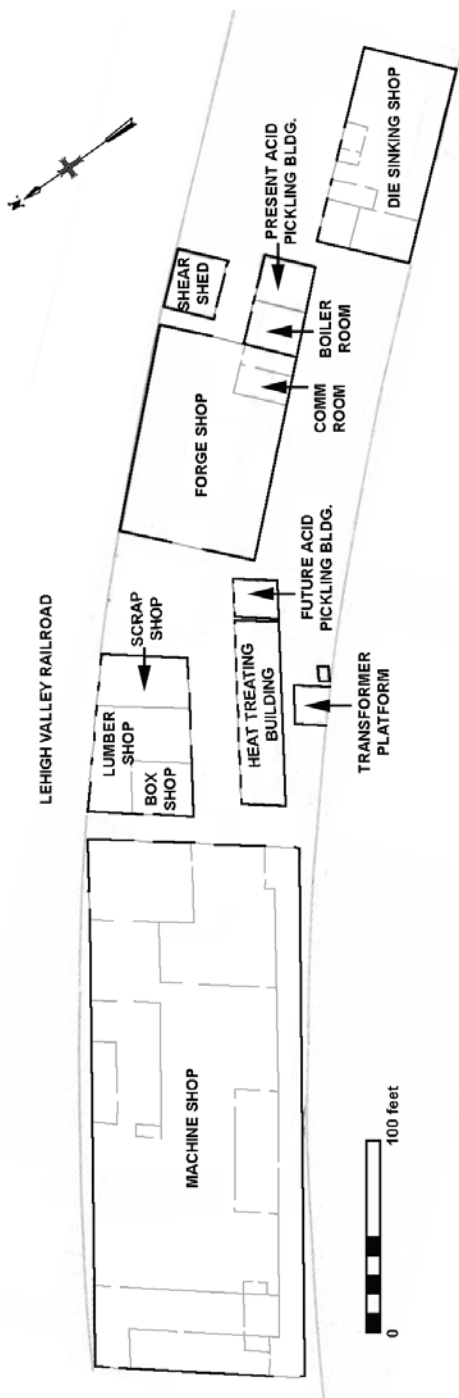

**Figure 7. SOUTH PLAINFIELD WORKS IN 1913**  
Source: redrawn from Spicer Manufacturing Company 1913



**SPICER MANUFACTURING COMPANY, SOUTH PLAINFIELD WORKS**

(Spicer Manufacturing Corporation, South Plainfield Works)

HAER No. NJ-144

(Page 40)

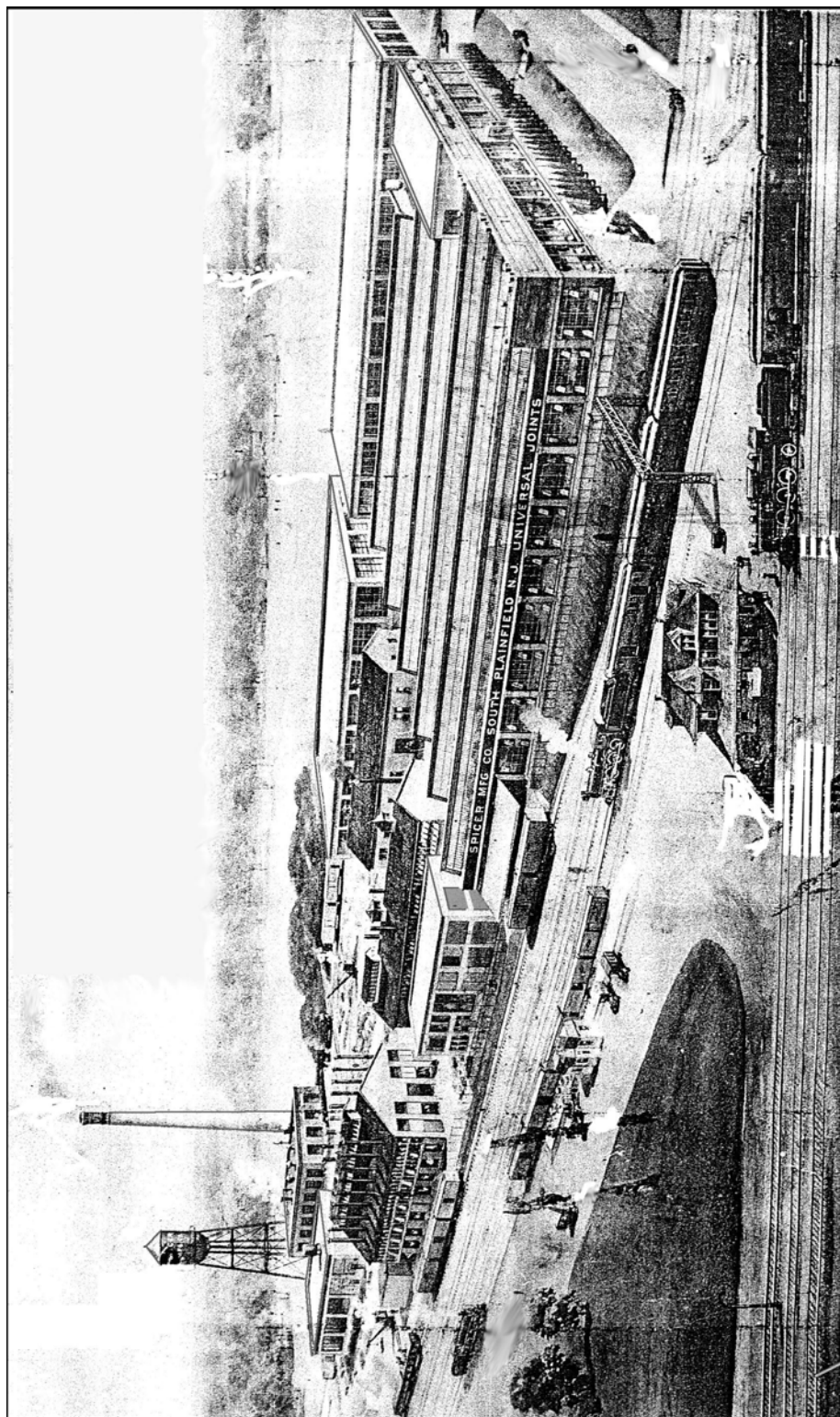

**Figure 8. 1915 VIEW SOUTH OF SOUTH PLAINFIELD WORKS**

Source: Spicer Manufacturing Company 1915

SPICER MANUFACTURING COMPANY, SOUTH PLAINFIELD WORKS

(Spicer Manufacturing Corporation, South Plainfield Works)

HAER No. NJ-144

(Page 41)

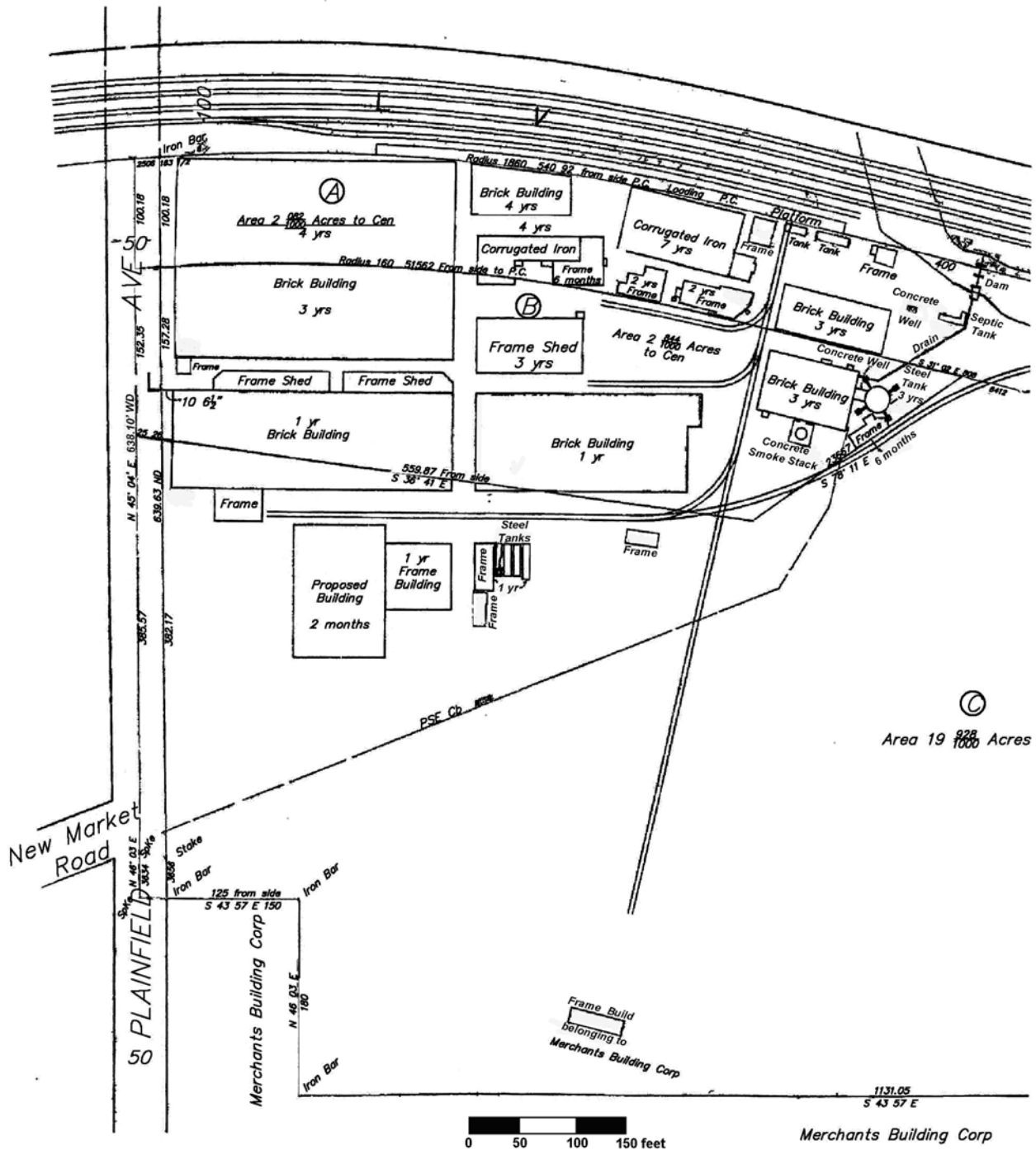

Figure 9. 1917 SOUTH PLAINFIELD WORKS

Source: Dunham-Clarín Company 1917, with re-lettering



**Figure 10. 1923 VIEW SOUTH OF SOUTH PLAINFIELD WORKS**  
Source: Spicer Manufacturing Corporation 1923

# SPICER MANUFACTURING COMPANY, SOUTH PLAINFIELD WORKS

(Spicer Manufacturing Corporation, South Plainfield Works)

HAER No. NJ-144

(Page 43)

DEPARTMENT				BUILDING	
No.	Name	Area	No.	Name	Area
1	Office	11640	1	Administration	49800
2	Eng. & Drafting	37760	2	Machine Shop	25922
3	Stores	4120	3	Receiving & Misc.	7340
4	Dies	10260	4	Heat Treat & Sand Blast	5300
5	Ferrous	8100	5	Maintenance and Millwright	8870
6	Sleeves & Balls	14100	6	Stamping	18968
7	Flanges	14100	7	Forging	4730
8	Shafts	5800	8	Power House	6000
9	Heat Treat	9800	9	Wash House	1425
10	Inspection	700	10	Shipping	780
11	Finished & Semi-Finished	6810	11	Welding and Storage	13190
12	Assembly, Welding, Receiving, & Shipping	35072	12	Shipping	9025
13	Tool Room	960	13	Assembly & Prod. Office	16920
14	Machine Repair	8310	14	Tram Shed	1700
15	Power House	6850	15	Pump House	220
16	Stamping	19270	16	Blacksmith Shop & Heat Treat	1000
17	Service	1800	17	Oil House	5200
18	Plumbing	1600	18	Forge	1620
19	Electrical	1925	19	Well Pump House	170
20	Guards	22	20	Storage & Garage	41600
21	Receiving	8150	21	Well Pump & Guard House	182
22	Factory Stores	5228	22	Water Softener Bldg	560
23	Blacksmith	1000	23		
24	Tool Crib	1360	24		
25	Experimental	1600	25		
26	Spring	1610	26		
27	Service Stores	2400	27		
28	Clutch	13490	28		
29	Filing and Burring	300	29		
30	Broach	3540	30		
31	Special Parts	3200	31		
32	Shear & Trim	2425	32		
33	Chemical	670	33		
34	Hospital	550	34		
35	Restaurant	2400	35		
36	Journal	3620	36		
37	Latatories-General	1800	37		
38	Garage	9600	38		
39	Elect. Truck Charging	1200	39		
40	Shipping	400	40		
	Total	250002		Total	250002

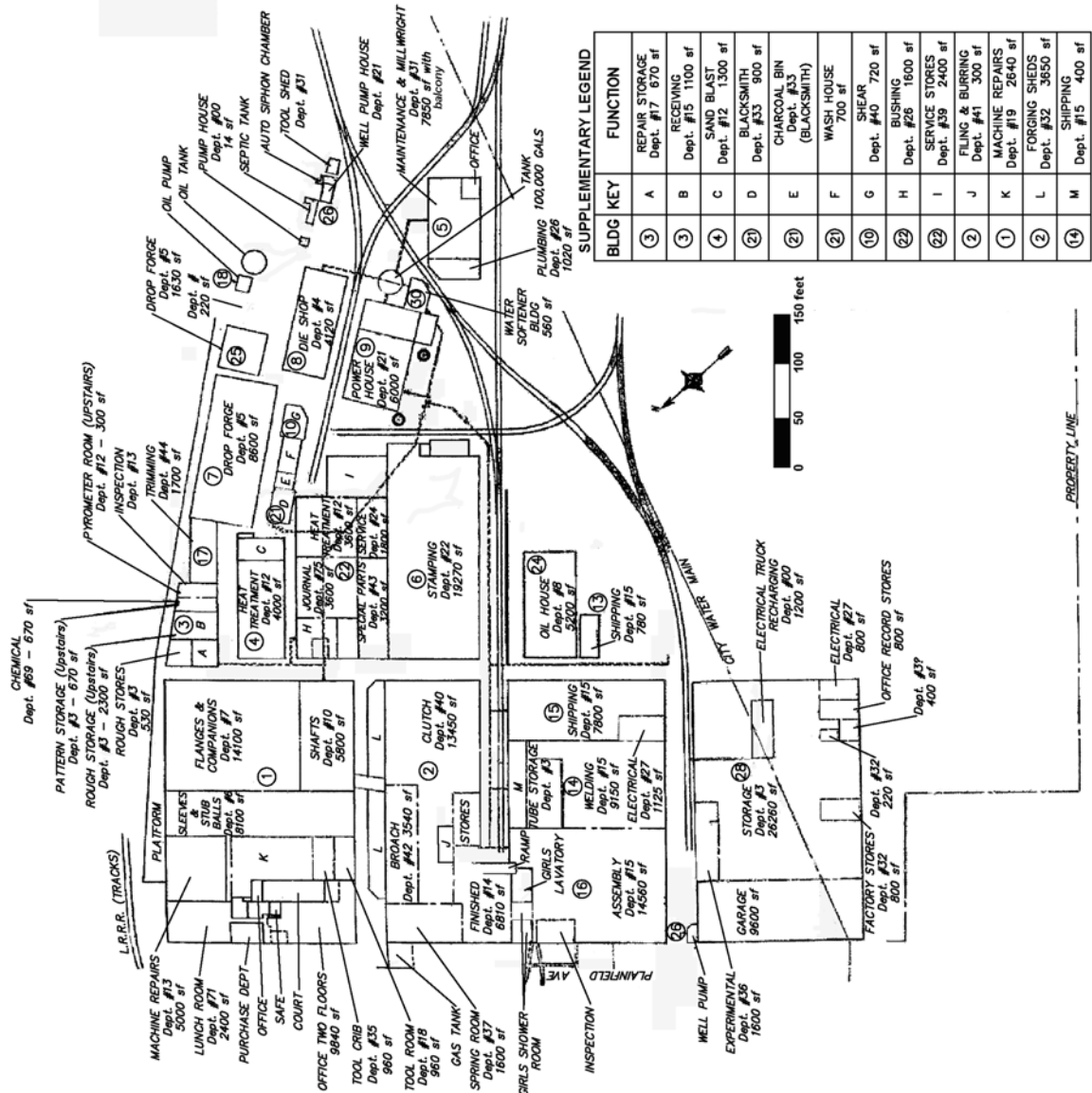

Figure 11. 1926 SOUTH PLAINFIELD WORKS  
Source: Spicer Manufacturing Corporation 1926, with re-lettering

SPICER MANUFACTURING COMPANY, SOUTH PLAINFIELD WORKS

(Spicer Manufacturing Corporation, South Plainfield Works)

HAER No. NJ-144

(Page 44)

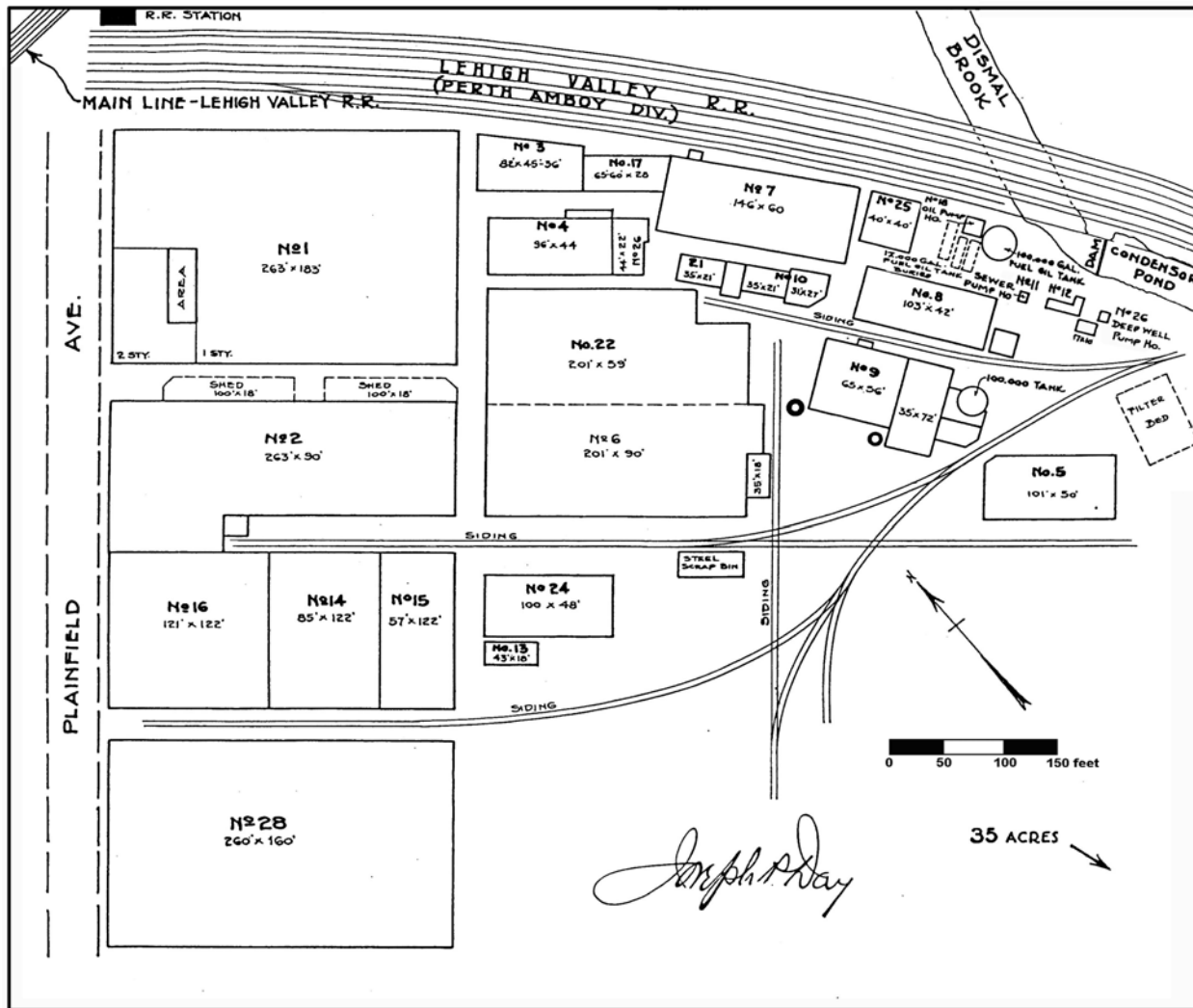

Figure 12. 1929 SOUTH PLAINFIELD WORKS

Source: Day 1929

ADDENDUM TO:  
SPICER MANUFACTURING COMPANY, SOUTH PLAINFIELD  
WORKS  
(Spicer Manufacturing Corporation, South Plainfield Works)  
333 Hamilton Avenue  
South Plainfield  
Middlesex County  
New Jersey

HAER NJ-144  
*HAER NJ-144*

PHOTOGRAPHS

WRITTEN HISTORICAL AND DESCRIPTIVE DATA

HISTORIC AMERICAN ENGINEERING RECORD  
National Park Service  
U.S. Department of the Interior  
1849 C Street NW  
Washington, DC 20240

**ADDENDUM TO**  
**SPICER MANUFACTURING COMPANY, SOUTH PLAINFIELD WORKS**  
HAER No. NJ-144  
(Page 45)

**HISTORIC AMERICAN ENGINEERING RECORD**

**SPICER MANUFACTURING COMPANY, SOUTH PLAINFIELD WORKS**  
(Spicer Manufacturing Corporation, South Plainfield Works)

This report is an addendum to a 44-page report previously submitted to the Library of Congress in 2012.

Location: 333 Hamilton Boulevard  
Borough of South Plainfield  
Middlesex County  
New Jersey

U.S. Geological Survey Plainfield Quadrangle  
The South Plainfield Works is located at latitude: 40.57669790, longitude:  
-74.4126481. The coordinates were confirmed in Google Earth in 2022.

Dates of Construction: c1910-1926

Present Owners: DSC of Newark Enterprises, Inc.  
70 Blanchard Street  
Newark, NJ 07105

Present Use: Demolished

Project Information: The previous documentation addressed South Plainfield Works components within the Cornell-Dubilier Electronics Superfund Site Operable Unit 2. Except for a water tank, the structures already documented have been demolished. Additional work proposed within Cornell-Dubilier Electronics Superfund Site Operable Unit 4 along Bound Brook, upstream of the former multi-track Lehigh Valley Railroad Perth Amboy Branch (now Conrail), will remove or otherwise affect several extant remains of the South Plainfield Works not previously documented, including part of a rail spur which served the plant. Based on consultations among the United States Army Corps of Engineers, the United States Environmental Protection Agency, and the New Jersey State Historic Preservation Office (NJSHPO), these features were documented to HAER Level 3 standards. The additional documentation was completed between 2019 and 2022.

**SPICER MANUFACTURING COMPANY, SOUTH PLAINFIELD WORKS**

(Spicer Manufacturing Corporation, South Plainfield Works)

HAER No. NJ-144

(Page 46)

Project Manager and Historian

Michael S. Raber

Raber Associates

South Glastonbury, CT 06073

Photographer and Associate Historian

Gerald Weinstein

New York, NY 10024

Associate Historian

Eugene J. Boesch

ARCADIS U.S., Inc.

Buffalo, NY 14202

Additional Research Assistance

Larry Randolph, Avocational Historian/Archaeologist; Dorothy Miele, President

South Plainfield Historical Society

South Plainfield, New Jersey 07080

Sara Beth Mouch, Curator/University Archivist; Tamara Jones/Archivist

Carlson Library

Ward M. Canaday Center for Special Collections

University of Toledo, Toledo, Ohio 43606



## SPICER MANUFACTURING COMPANY, SOUTH PLAINFIELD WORKS

(Spicer Manufacturing Corporation, South Plainfield Works)

HAER No. NJ-144

(Page 47)

The Cornell Dubilier Electronics Superfund Site in South Plainfield, New Jersey included fifteen structures associated with the Spicer Manufacturing Company (SMC) and its successor firm, the Spicer Manufacturing Corporation (SMCorp), built during the period 1910-1929. SMC began operations in 1904 in Plainfield, New Jersey, and moved to the more rural South Plainfield site in 1910 after the noise of expanding SMC operations in Plainfield led to local complaints. The 2-acre tract on which the South Plainfield Works was first established was adjacent to the Perth Amboy Branch of the Lehigh Valley Railroad, extending southeast from Hamilton Boulevard approximately 750 feet to Bound Brook just upstream of the brook's passage under the railroad. As initially built with a rail spur parallel to the railroad, the plant operated with four buildings within this tract c1910-1912. Subsequent plant expansions, discussed in the original report for HAER No. NJ-144, were made further southeast away from the railroad c1914-1916, and c1918-1920 in association with increased production during World War I. The general spatial pattern of expansion was to erect new structures parallel to the first factory buildings, creating a series of rectangular blocks separated by narrow alleys and served by new rail spurs. Other than often-incomplete maps and views showing the plant, there appears to be no documentation of spur design, lay-out, and construction, and all spurs were removed in the area of the Cornell-Dubilier Electronics Superfund Site Operable Unit 2 prior to the documentation prepared for the original HAER No. NJ-144 report (See Appendix, Figures 1, 3, 5).

Rail spurs serving post-1912 plant areas had to include a crossing of Bound Brook east of the newer SMC buildings. As part of the first phase of expansion, a powerhouse with a large condenser pond was built in 1915 (see HAER No. NJ-144-J). The pond, created by damming the brook, covered a large area east of the plant buildings. The spurs serving the plant facilities built c1914-1916 crossed the brook on a track carried by a 35'-long trestle approximately 125 feet upstream of the condenser pond impoundment, where the pond was left narrow. This spur and trestle were removed c1945. Standard-gauge spurs serving the last plant expansion built c1918-1920 also used this short stream crossing, but the additional traffic for Spicer operations required a second junction with the Lehigh Valley Railroad tracks further south. To create the second junction, Spicer built a spur track with an approximately 550'-long crossing of the condenser pond, a very substantial project most likely built c1918 in response to World War I production demands. One bird's-eye view created for the company indicates the pond crossing was a solid-fill structure with two concrete conduits allowing for stream and pond flow. Construction could have involved use of dump trucks which were increasing in use and size during World War I, or could have included initial construction of a long trestle around which fill was placed using dump cars traveling on the tracks. No maps or plans show this spur before the pond was drained c1930, shortly after SMCorp completed relocation of all South Plainfield operations to Toledo, OH. The pond was later filled by Cornell-Dubilier Electric Corporation, which appears to have added an additional short rail spur meeting the long one built across the former pond; the short spur has been removed. Pond filling left tracks from the west half of the embankment intact until recently. Aerial photographs also suggest Cornell-Dubilier installed a third concrete conduit in the rail spur embankment c1960, probably to enhance stream flow conditions (See Appendix, Figures 3-5) (Dunham-Clarín Company 1917; Spicer Manufacturing Corporation 1923, 1926; Day 1929; New Jersey Historic Preservation Office n.d.; MyTruckNation 2020).

**SPICER MANUFACTURING COMPANY, SOUTH PLAINFIELD WORKS**

(Spicer Manufacturing Corporation, South Plainfield Works)

HAER No. NJ-144

(Page 48)

In 2020 approximately 880 feet of track from the c1918 spur which had crossed the pond survived. The spur embankment, over open water or surrounded by fill placed in the pond, was intact for approximately 250 feet. The embankment was approximately 40 feet wide from toe to toe, with a 20'-wide track surface approximately 5 feet above the estimated elevation of the former condenser pond. There was no visual evidence of any trestle which might have been installed during original construction. The track was standard gauge on 8"-to-9"-wide timber ties. The lack of stampings on the rails which would have been required for railroad construction suggests SMCorp purchased the rail from a supplier serving factories rather than railroad companies. The original 92-inch-diameter, 36'-long precast concrete conduits, centered 10 feet apart, are of bell-and-spigot construction with approximately 7'-long, 5'-high, 1.5' wide concrete wing walls on the downstream sides. The later 70"-diameter, 55'-long pre-cast concrete conduit, located 40 feet east of the original eastern conduit, appears to be built in several sections (See Appendix, Figures 2, 6 and photographs HAER No. NJ-144-6 and NJ-144-7) (American Railway Engineering and Maintenance of Way Association 1905).

## SPICER MANUFACTURING COMPANY, SOUTH PLAINFIELD WORKS

(Spicer Manufacturing Corporation, South Plainfield Works)

HAER No. NJ-144

(Page 49)

### SOURCES OF INFORMATION/BIBLIOGRAPHY

Arcadis U.S., Inc.

- 2018 Topographic Site Plan. Cornell-Dubilier Electronics Superfund Site OU4: Phase 1/South Plainfield, New Jersey. Prepared for U.S. Army Corps of Engineers.

Bennett, Jeffrey R.

- 2006 Site Plan/Cluster Designations. Cornell-Dubilier Electronics Superfund Site OU2 Building Demolition/South Plainfield, New Jersey. Prepared for U.S. Army Corps of Engineers and Malcolm Pirnie Inc.

American Railway Engineering and Maintenance of Way Association

- 1905 *Manual of Recommended Practice for Railway Engineering and Maintenance of Way*. Chicago: Press of Blakely Printing Company

Day, Joseph P.

- 1929 3 Factories for Sale Formerly Occupied by Spicer Mfg. Co. Joseph P. Day Real Estate Agent, New York, New York. Obtained from former Dana-Spicer Corporation Archives. Miscellaneous Documents, Box 74, Sheet 2. The History Factory, Chantilly, Virginia; document later transferred to Dana Corporation Archives University of Toledo.

Dunham-Clarín Company

- 1917 Map of Property Situated at South Plainfield, Middlesex County, New Jersey, Property of Spicer Manufacturing Corporation, July, 11, 1917. Dana Corporation Archives University of Toledo, University of Toledo Libraries, Ward M. Canaday Center, Manuscript Collection MSS-242, SK-01516, M-01881, Folder 2.

MyTruckNation

- 2020 The History of Dump Trucks. Accessed August 1, 2022 on World Wide Web at <https://www.mjtrucknation.com/the-history-of-dump-trucks/>

Spicer Manufacturing Corporation

- 1923 South Plainfield Works of the Spicer Manufacturing Corporation, South Plainfield, New Jersey. Copy in Dana Corporation Archives University of Toledo, University of Toledo Libraries, Ward M. Canaday Center, Miscellaneous materials, MSS-242, Folder 2.

- 1926 Department and Building Location Plan, Spicer Manufacturing Corporation, South Plainfield, New Jersey. Revised by Albright, July 1, 1926. Copy in Dana Corporation Archives University of Toledo, University of Toledo Libraries, Ward M. Canaday Center, Miscellaneous materials, MSS-242, SK-01516, M-01881, Folder 2.

Appendix

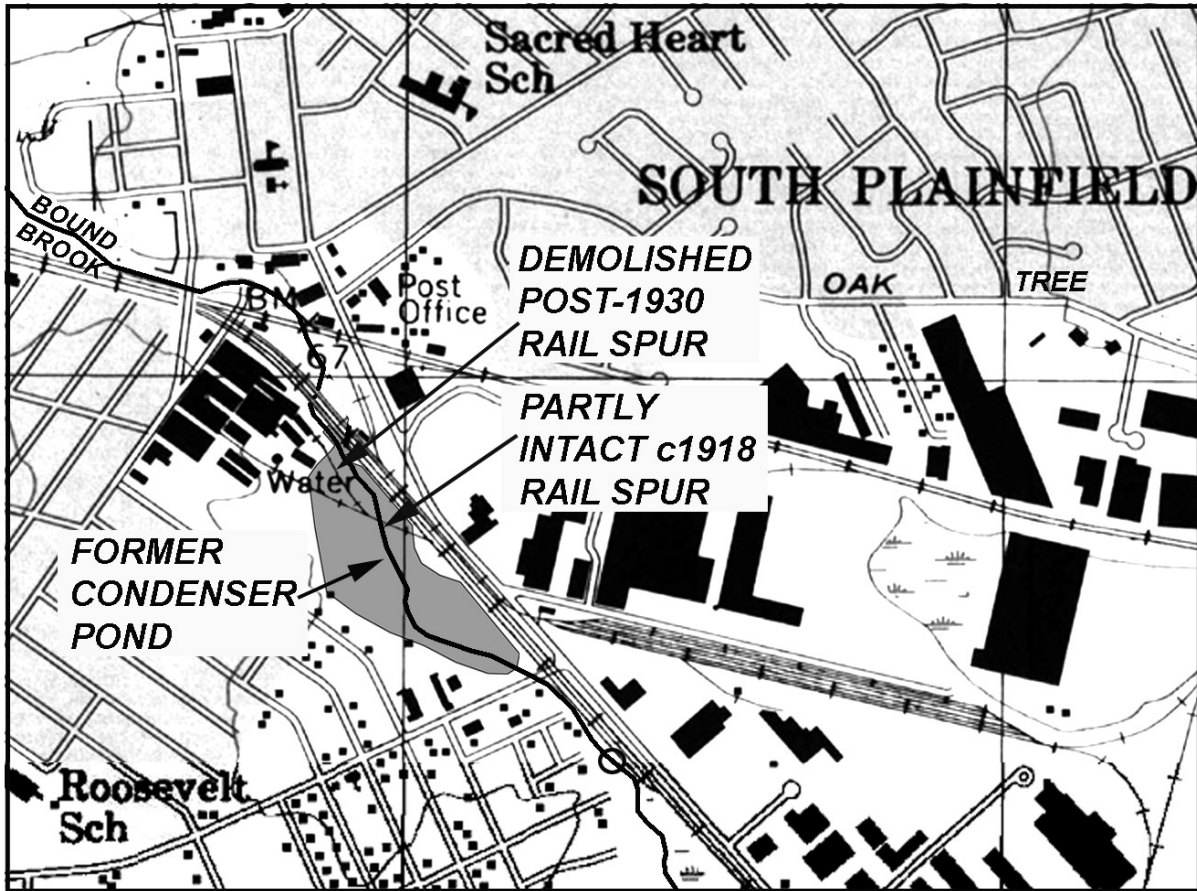
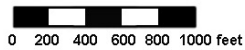

Figure 1. LOCATIONS OF FORMER POWERHOUSE, APPROXIMATE CONDENSER POND AND CHECK DAM

base image: U.S. Geological Survey 1995 Plainfield, N.J. Quadrangle

data sources: Dunham-Clarín Company 1917; New Jersey Department of Environmental Protection n.d.; Bennett 2006



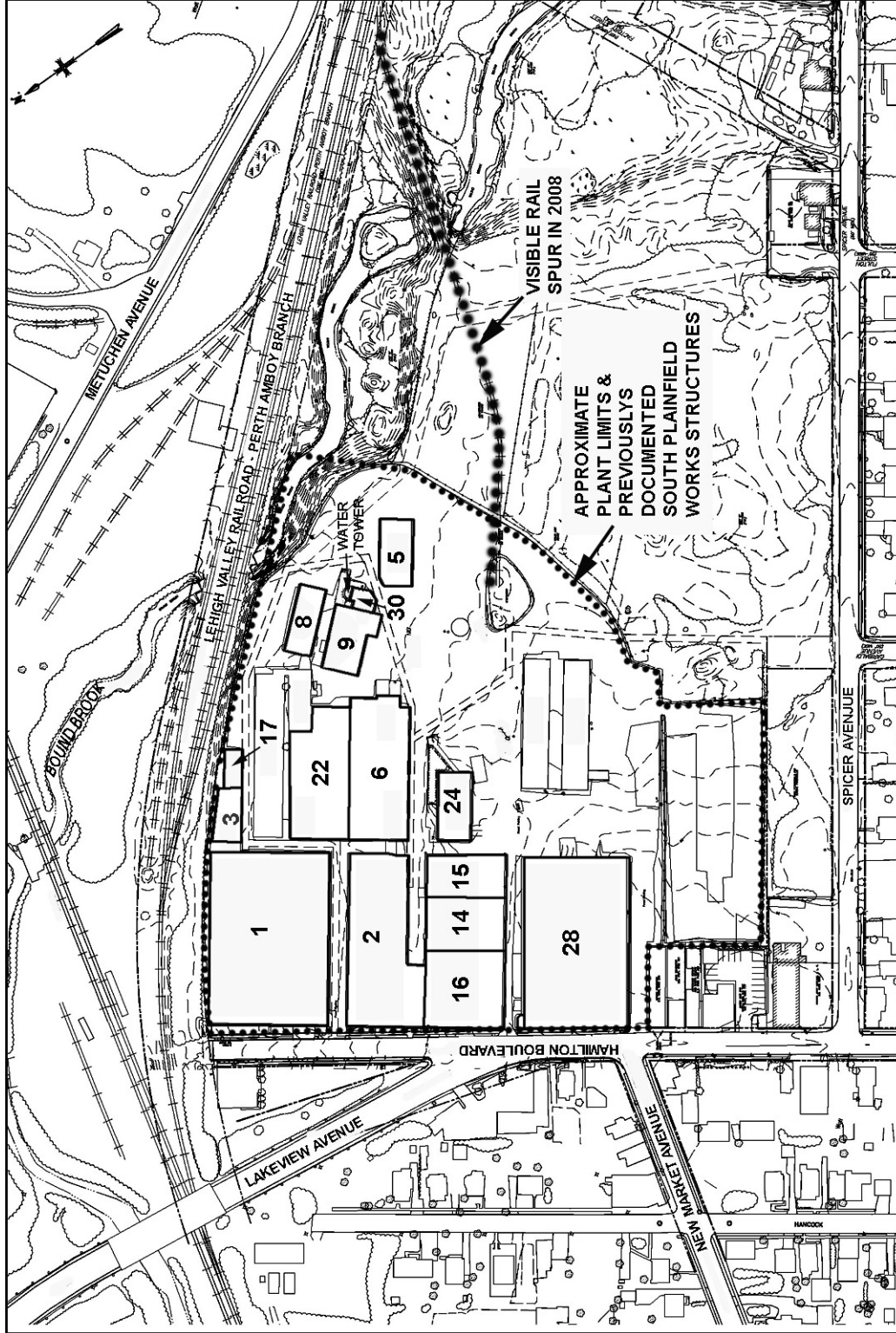

Figure 2. SOUTH PLAINFIELD WORKS RAILSPUR VISIBLE IN 2006  
AND LIMITS OF PREVIOUS DOCUMENTATION  
Base image: Bennett 2006

**SPICER MANUFACTURING COMPANY, SOUTH PLAINFIELD WORKS**

(Spicer Manufacturing Corporation, South Plainfield Works)

HAER No. NJ-144

(Page 52)

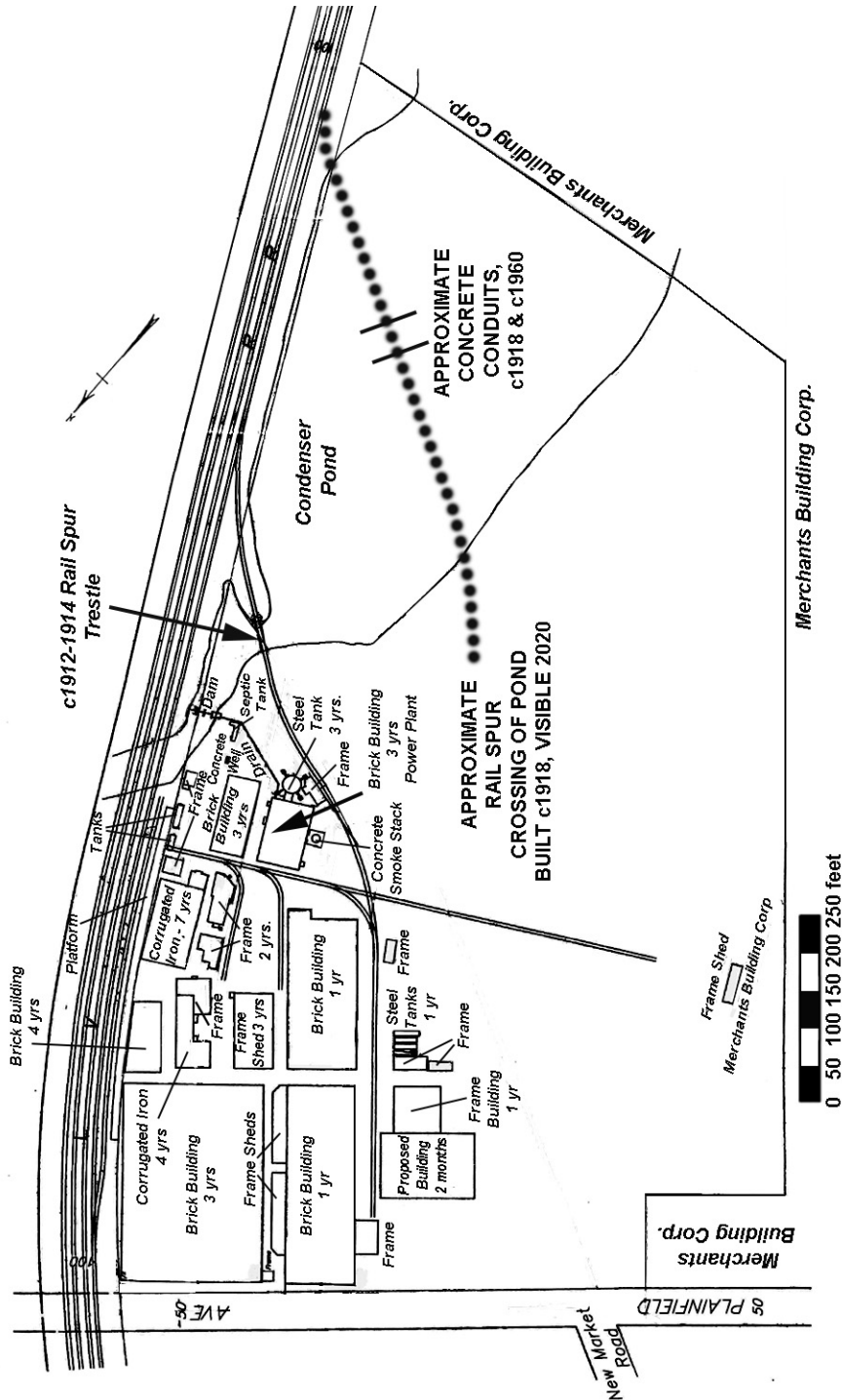

**Figure 3. 1917 SOUTH PLAINFIELD WORKS WITH c1918 RAIL SPUR ACROSS CONDENSER POND**

Base image: Dunham-Clarim Company 1917, with re-lettering

Rail spur location: Bennett 2006

**SPICER MANUFACTURING COMPANY, SOUTH PLAINFIELD WORKS**

(Spicer Manufacturing Corporation, South Plainfield Works)

HAER No. NJ-144

(Page 53)

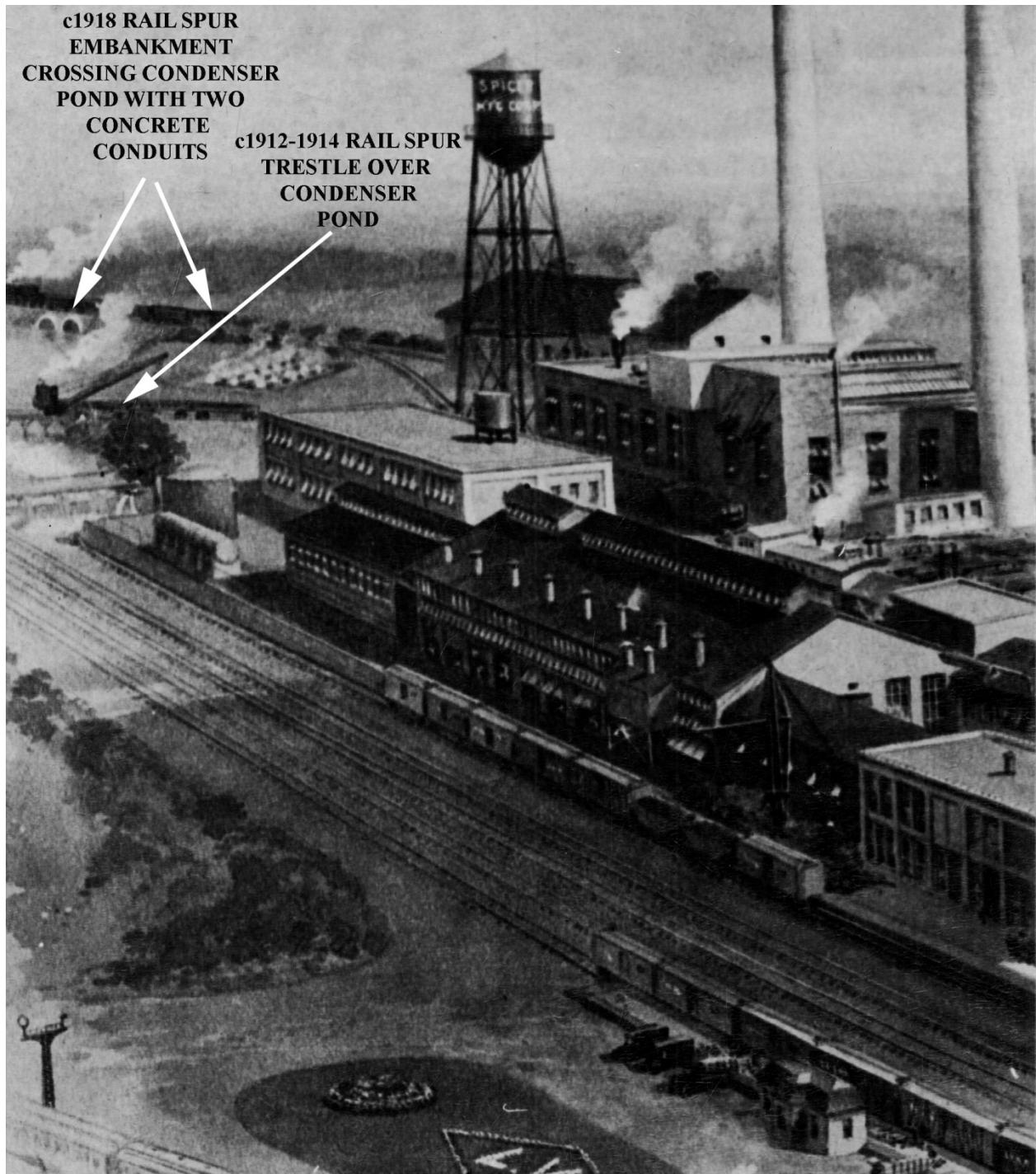

**Figure 4. DETAIL FROM 1923 SOUTHEAST-FACING BIRDS'-EYE VIEW OF SOUTH PLAINFIELD WORKS, SHOWING RAIL SPURS CROSSING CONDENSER POND**  
Base image: Spicer Manufacturing Corporation 1923

**SPICER MANUFACTURING COMPANY, SOUTH PLAINFIELD WORKS**  
 (Spicer Manufacturing Corporation, South Plainfield Works)  
 HAER No. NJ-144  
 (Page 54)

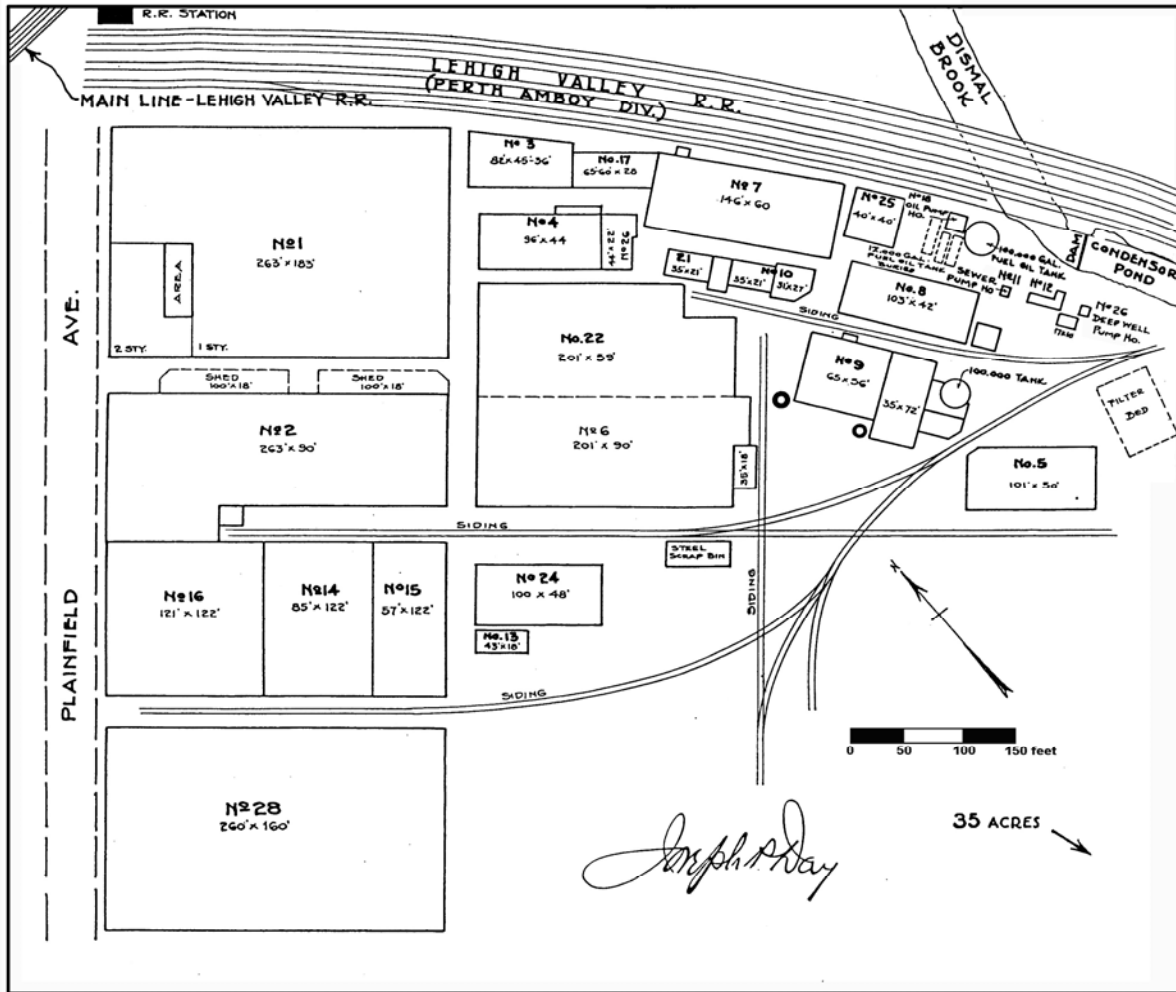

**Figure 5. 1929 SOUTH PLAINFIELD WORKS**  
 Base image: Day 1929



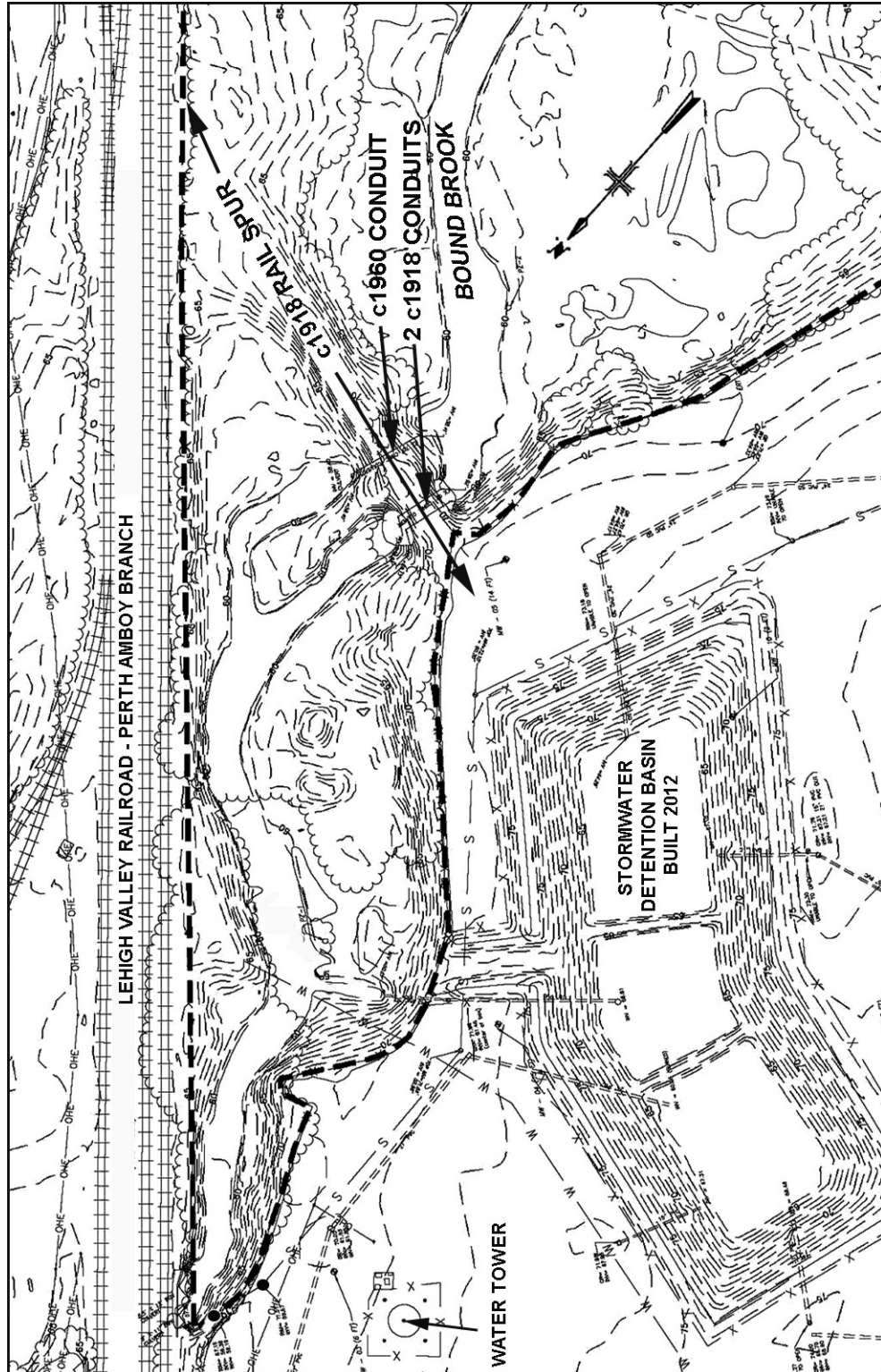

Figure 6. DETAIL c1918 RAIL SPUR LOCATION IN 2018  
Base image: ARCADIS U.S., INC. 2018